

ABB solar inverters

Product manual

TRIO-50.0-TL-OUTD ; TRIO-60.0-TL-OUTD-480
(from 50 to 60 kW)



ABB



IMPORTANT SAFETY INSTRUCTIONS

This manual contains important safety instructions that must be followed during the installation and maintenance of the equipment.



SAVE THESE INSTRUCTIONS!

Keep this document in a safe place near the inverter for easy access during installation, operation and maintenance.

THE INSTALLER MUST READ THIS DOCUMENT IN ITS ENTIRETY BEFORE INSTALLING THIS EQUIPMENT.

Operators are required to read this manual and scrupulously follow the instructions given in it, since ABB cannot be held responsible for damage caused to people and/or things, or the equipment, if the conditions described below are not observed.

The purpose of this document is to support the qualified technician, who has received training and/or has demonstrated skills and knowledge in construction, to install, operate and maintain the inverter. This manual covers only inverter, not any equipment (photovoltaic modules, external disconnects, etc) to which it is connected.

Warranty requirements are included in the Terms and Conditions of sale included with the inverter order.

Any changes not approved by ABB void the warranty.

Product manual

TRIO-50.0/60.0 string inverters

1 - Introduction and general information



2 - Characteristics



3 - Safety and accident prevention



4 - Lifting and transport



5 - Installation



6 - Instruments



7 - Operation



8 - Maintenance



Warranty and supply conditions

The warranty conditions are considered to be valid if the Customer adheres to the indications in this manual; any conditions deviating from those described herein must be expressly agreed in the purchase order.

ABB declares that the equipment complies with the provisions of law currently in force in the country of installation and has issued the corresponding declaration of conformity.

Not included in the supply

ABB accepts no liability for failure to comply with the instructions for correct installation and will not be held responsible for systems upstream or downstream of the equipment it has supplied.



It is absolutely forbidden to modify the equipment. Any modification, manipulation, or alteration not expressly agreed with the manufacturer, concerning either hardware or software, shall result in the immediate cancellation of the warranty.

The customer is fully responsible for any changes made to the system.

Given the countless array of system configurations and installation environments possible, it is essential to check the following: adequate spaces, suitable for housing the equipment; airborne noise produced based on the environment; possible flammability conditions.

ABB will NOT be held liable for defects or malfunctions arising from: improper use of the equipment; deterioration resulting from transportation or particular environmental conditions; performing maintenance incorrectly or not at all; tampering or unsafe repairs; use or installation by unqualified persons.

ABB is not responsible for any loss of the equipment, or part of it, which does not take place on the basis of the regulations and laws in force in the country of installation.

Table of Contents

Introduction and general information	4
Warranty and supply conditions	4
Not included in the supply.....	4
Table of Contents	5
Scope and target audience	8
Purpose and document structure	8
List of appendix documents	8
Operator and maintenance personnel skills/prerequisites	8
Symbols and signs	9
Field of use, general conditions	11
Intended or allowed use.....	11
Limits in field of use.....	11
Improper or prohibited use	11
Characteristics	12
General conditions	12
Identification of the equipment and manufacturer	13
Models and range of equipment	16
List of main reference components	17
DC wiring box Standard / -S / -SX / -SY version	18
AC wiring box Standard -S / -SX version.....	19
Principal wiring box components	20
Characteristics and technical data	22
Tightening torques	24
Cable gland clamping range.....	24
Overall dimensions	25
Dimensions of vertical wall assembly bracket.....	26
Horizontal wall assembly bracket.....	26
Efficiency curves	27
Power limitation (Power Derating)	28
Power reduction due to environmental conditions.....	28
Power reduction due to the input voltage	29
Power reduction due to the grid voltage	29
P- Q curve capability.....	30
Characteristics of a photovoltaic generator	31
Strings and Arrays.....	31
Description of the equipment	32
Operating diagram	32
Mutual connection of multiple inverters	33
Notes on the system sizing.....	33
Functionality and components of the equipment.....	34
Topographic diagram of the equipment	35
Safety devices	37
Anti-Islanding	37
Ground fault of the photovoltaic panels	37
String fuses	37
Overvoltage surge arresters	37
Other safeguards	38



Safety and accident prevention	39
Safety information and instructions	39
Hazardous areas and operations	40
Environmental conditions and risks	40
Signs and labels	40
Thermal and electrical hazard	41
Clothing and protection of personnel	41
Residual risks	42
Table of residual risks	42
Lifting and transport	43
General conditions	43
Transport and handling	43
Lifting	43
Unpacking and checking	43
Storage	44
Weight of the modules of the equipment	44
Types of lifting	45
List of components supplied	46
Kit of recommended spare parts	47
Installation	48
General conditions	48
Installation site and position	49
Installations above 2000 metres	51
Installations with a high level of humidity	51
Mounting with a support bracket	52
Mounting on a vertical support	52
Mounting on a horizontal support	58
Grid output connection (AC side)	64
Characteristics and sizing of the protective grounding cable	64
Characteristics and sizing of the line cable	65
Load protection switch (AC disconnect switch)	65
Connection to terminal block AC side	66
Installation of the second protective earthing cable	68
Operations preliminary to the connection of the PV generator	69
Checking of leakage to ground of the photovoltaic generator	69
Checking of strings voltage	70
Checking the correct polarity of the strings (standard / -S versions)	70
Selection of differential protection downstream of the inverter	70
Configuration of the input channels	72
Input connection to PV generator (DC side)	72
Connection of inputs on the Standard and -S models	73
Connection of inputs on the -SX / -SY models	74
Checking the correct polarity of the strings (-SX / -SY versions)	75
Installation procedure for quick-fit connectors	76
String protection fuses (-SX / -SY models only)	80
Sizing of fuses	80
Communication and control board	82
Connections to the communication and control board	83
Remote control connection	83



Configurable Relay connection (ALARM and AUX)	84
Connector for expansion board installation (optionals)	85
Connector for PMU expansion board installation (optional).....	86
Serial Communication connection (RS485)	87
Monitoring and control systems	89
Procedure for RS485 connection to a monitoring system.....	89
Instruments.....	91
General conditions	91
Description of the LED function	92
LED insulation fault	92
Aurora Manager LITE - Advanced configuration software	93
Operation.....	94
General conditions	94
Monitoring and data transmission	95
User interface mode.....	95
Types of data available	95
Measurement tolerance	95
Preliminary operations before commissioning	96
Setting the national grid standard	96
Saving the country grid standard and language.....	97
Installing the Wiring Box cover and conductive springs	98
Commissioning.....	99
Pre commissioning inspection	99
Commissioning procedure.....	99
Enabling and default parameters.....	100
LED behaviour	101
Setting Parameters	103
The information is available through the dedicated software	110
Inverter switch-off.....	111
AC and DC wiring box version (Standard)	111
DC (-S / -SX / -SY) and AC (-S / -SX) wiring box version	112
Maintenance.....	113
General conditions	113
Routine maintenance	114
Alarm Messages and troubleshooting	114
Power limitation messages	127
Procedure for dismantling the Inverter and wiring box.....	129
Obtaining the Aurora Manger LITE credentials - Registering at the “Registration” site	130
Replacing DC string fuses (-SX / -SY versions).....	131
Replacement of the buffer battery.....	132
Verification of ground leakage	133
Behaviour of a system without leakage	133
Behaviour of a system with leakage	134
Measuring the insulation resistance of the PV generator.	135
Storage and dismantling	136
Storage of the equipment or prolonged stop	136
Dismantling, decommissioning and disposal.....	136
Further information	137
Contact us	138



Scope and target audience

Purpose and document structure

This operating and maintenance manual is a useful guide that will enable you to work safely and carry out the operations necessary for keeping the equipment in good working order.



If the equipment is used in a manner not specified in this manual, the protection provided by the equipment may be impaired.



The language in which the document was originally written is ITALIAN; therefore, in the event of inconsistencies or doubts please ask the manufacturer for the original document.

List of appendix documents

In addition to this user manual and maintenance you can consult (and download) the product documentation by visiting www.abbsolarinverters.com.



Part of the information given in this document is taken from the original supplier documents. This document contains only the information considered necessary for the use and routine maintenance of the equipment.

Operator and maintenance personnel skills/prerequisites



Personnel in charge of using and maintaining the equipment must be skilled for the described tasks and must reliably demonstrate their capacity to correctly interpret what is described in the manual.



For safety reasons, only a qualified electrician who has received training and/or demonstrated skills and knowledge of the inverter's structure and operation may install the inverter.



The installation must be performed by qualified installers and/or licensed electricians in accordance with the existing regulations in the country of installation.









Inverter operation and maintenance by a person who is NOT qualified, is intoxicated, or on narcotics, is strictly forbidden.











The customer has civil liability for the qualification and mental or physical state of the personnel who interact with the equipment. They must always use the personal protective equipment (PPE) required by the laws of the country of destination and whatever is provided by their employer.

Symbols and signs

In the manual and/or in some cases on the equipment, the danger or hazard zones are indicated with signs, labels, symbols or icons.

Symbol	Description
	Indicates that it is mandatory to consult the manual or original document, which must be available for future use and must not be damaged in any way.
	General warning - Important safety information. Indicates operations or situations in which staff must be very careful.
	Dangerous Voltage - Indicates operations or situations in which staff must be very careful with regard to dangerous voltage levels.
	Hot parts - Indicates a risk arising from the presence of hot zones or zones with parts at high temperatures (risk of burns).
	Risk of explosion
	Risk of injury due to the weight of the equipment. Take care during lifting and transport
	Indicates that the area in question must not be accessed or that the operation described must not be carried out.
	Keep out of the reach of children
	Indicates that smoking and the use of naked flames is prohibited.
	Indicates that it is mandatory to carry out the described operations using the clothing and/or personal protective equipment provided by the employer.
	WEEE logo. Indicates that the product is to be disposed of according to current legislation regarding the disposal of electronic components.
	Indicates the protection rating of the equipment according to IEC 70-1 (EN 60529 June 1997) standard.
	Point of connection for grounding protection.
	Indicates the permitted temperature range



Symbol	Description
	Indicates a risk of electric shock. The discharge time of the stored energy (represented in the figure by the letters XX), is provided on the identification label.
	Direct Current
	Alternate current
	With insulation transformer
	Without insulation transformer
	Positive pole of the input voltage (DC)
	Negative pole of the input voltage (DC)
	Indicates the centre of gravity of the equipment.
	Indicates the requirement to wear acoustic protection devices in order to prevent damage to hearing



Field of use, general conditions

ABB shall not be liable for any damages whatsoever that may result from incorrect or careless operations.



*You may not use the equipment for a use that does not conform to that provided for in the field of use. The equipment **MUST NOT** be used by inexperienced staff, or even experienced staff if carrying out operations on the equipment that fail to comply with the indications in this manual and enclosed documentation.*



Intended or allowed use

This equipment is a inverter designed for:
transforming a continuous electrical current (DC)
supplied by a photovoltaic generator (FV)
in an alternating electrical current (AC)
suitable for feeding into the public distribution grid.

Limits in field of use

The inverter can be used only with photovoltaic modules which have ground isolated input poles, unless they are accessories installed that enable earthing of the inputs. In this case you must install an insulating transformer on the AC side of the system.

Only a photovoltaic generator can be connected in the input of the inverter (do not connect batteries or other sources of power supply).

The inverter can be connected to the electricity grid only in countries for which it has been certified/approved.

The inverter cannot be connected to the DC side in parallel to other inverters to convert energy from a photovoltaic generator with a power greater than the nominal power of the single inverter.

The inverter may only be used in compliance with all its technical characteristics.

Improper or prohibited use



IT IS STRICTLY FORBIDDEN TO:

- *Install the equipment in environments subject to particular conditions of flammability or in adverse or disallowed environmental conditions, (temperature and humidity).*
- *Use the equipment with safety devices which are faulty or disabled.*
- *Use the equipment or parts of the equipment by linking it to other machines or equipment, unless expressly provided for.*
- *Modify operating parameters that are not accessible to the operator and/or parts of the equipment to vary its performance or change its isolation.*
- *Clean with corrosive products that could eat into parts of the equipment or generate electrostatic charges.*
- *Use or install the appliance or parts of it without having read and understood the contents of the user and maintenance manual.*
- *Heat or dry rags and clothing on the parts in temperature. In addition to being hazardous, doing so would compromise component ventilation and cooling.*



General conditions

A description of the equipment characteristics is provided to identify its main components and specify the technical terminology used in the manual.

This chapter contains information about the models, details of the equipment, characteristics and technical data, overall dimensions and equipment identification.



The customer/Installer takes full responsibility if, when reading this manual, the chronological order of its presentation provided is not observed. All information is provided considering occasional inclusion of information in previous chapters.



In certain cases, there may be a need to separately document software functionality or attach supplementary documentation to this manual which is intended for more qualified professionals.

Identification of the equipment and manufacturer

The technical data provided in this manual does not substitute the data supplied on the labels affixed to the equipment.



The labels affixed to the equipment must NOT be removed, damaged, stained, hidden, etc., for any reason whatsoever.

TRIO-50.0-TL-OUTD:



ABB 1 4 CE
 www.abb.com/solar
 Made in Italy
 PROTECTIVE CLASS: I

DC WIRING BOX
 (COMPONENT OF MODEL TRIO-50.0-TL-OUTD)

MODEL:
DCWB-TRIO-50.0-TL-OUTD 2

-20 to + 60 °C
 -4 to +140 °F

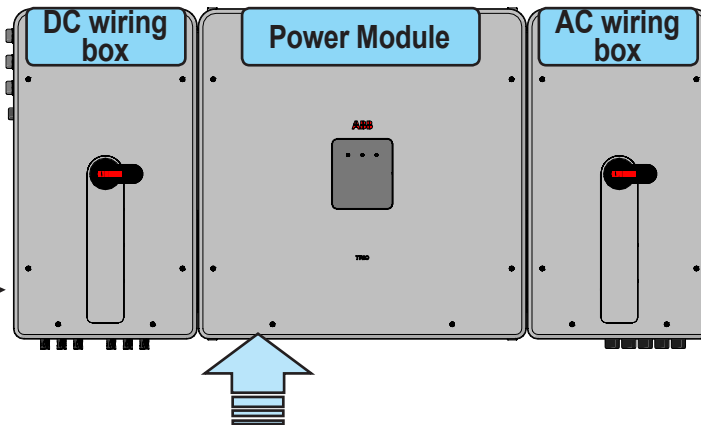
IP65

SSS

⚡

ABB 1 4 CE
 www.abb.com/solar
 Made in Italy

POWER MODULE
 (COMPONENT OF MODEL TRIO-50.0-TL-OUTD)
 PROTECTIVE CLASS: I

MODEL:
TRIO-50.0-TL-OUTD-POWER MODULE 2 4

SOLAR INVERTER
 MODEL:
TRIO-50.0-TL-OUTD

V _{dc} max	1000 V	V _{ac}	400 V 3Ø
V _{dc} MPP	300 - 950 V	f	50 / 60 Hz
V _{dc} Full Power	450 - 800 V	P _{max} (cosφ = 1)	50000 W
I _{dc} max	110 A	P _{max} (cosφ = 0.9)	45000 W
I _{ac} max	160 A	I _{ac} max	77 A

-20 to + 60 °C
 -4 to + 140 °F

IP65

IP54 Cooling Section

SSS

⚡

30 minutes

ABB 1 4 CE
 www.abb.com/solar
 Made in Italy
 PROTECTIVE CLASS: I

AC WIRING BOX
 (COMPONENT OF MODEL TRIO-50.0-TL-OUTD)

MODEL:
ACWB-TRIO-50.0-TL-OUTD 2

-20 to + 60 °C
 -4 to +140 °F

IP65

SSS

⚡

ABB 1 4 CE
 www.abb.com/solar
 Made in Italy
 PROTECTIVE CLASS: I

DC WIRING BOX
 (COMPONENT OF MODEL TRIO-50.0-TL-OUTD)

MODEL:
DCWB-S-TRIO-50.0-TL-OUTD 2

-20 to + 60 °C
 -4 to +140 °F

IP65

SSS

⚡

ABB 1 4 CE
 www.abb.com/solar
 Made in Italy
 PROTECTIVE CLASS: I

AC WIRING BOX
 (COMPONENT OF MODEL TRIO-50.0-TL-OUTD)

MODEL:
ACWB-S-TRIO-50.0-TL-OUTD 2

-20 to + 60 °C
 -4 to +140 °F

IP65

SSS

⚡

ABB 1 4 CE
 www.abb.com/solar
 Made in Italy
 PROTECTIVE CLASS: I

DC WIRING BOX
 (COMPONENT OF MODEL TRIO-50.0-TL-OUTD)

MODEL:
DCWB-SX-TRIO-50.0-TL-OUTD 2

-20 to + 60 °C
 -4 to +140 °F

IP65

SSS

⚡

ABB 1 4 CE
 www.abb.com/solar
 Made in Italy
 PROTECTIVE CLASS: I

AC WIRING BOX
 (COMPONENT OF MODEL TRIO-50.0-TL-OUTD)

MODEL:
ACWB-SX-TRIO-50.0-TL-OUTD 2

-20 to + 60 °C
 -4 to +140 °F

IP65

SSS

⚡

ABB 1 4 CE
 www.abb.com/solar
 Made in Italy
 PROTECTIVE CLASS: I

DC WIRING BOX
 (COMPONENT OF MODEL TRIO-50.0-TL-OUTD)

MODEL:
DCWB-SY-TRIO-50.0-TL-OUTD 2

-20 to + 60 °C
 -4 to +140 °F

IP65

SSS

⚡

The approval label contains the following information:

1. Manufacturer
2. Model
3. Rating data
4. Certification marks



The labels are NOT to be hidden by foreign objects and parts (rags, boxes, equipment, etc.); they must be regularly cleaned and always kept in sight.

TRIO-60.0-TL-OUTD-480:



ABB 1 4 Made in Italy

www.abb.com/solar

DC WIRING BOX
(COMPONENT OF MODEL TRIO-60.0-TL-OUTD-480)

MODEL:
DCWB-TRIO-60.0-TL-OUTD-2

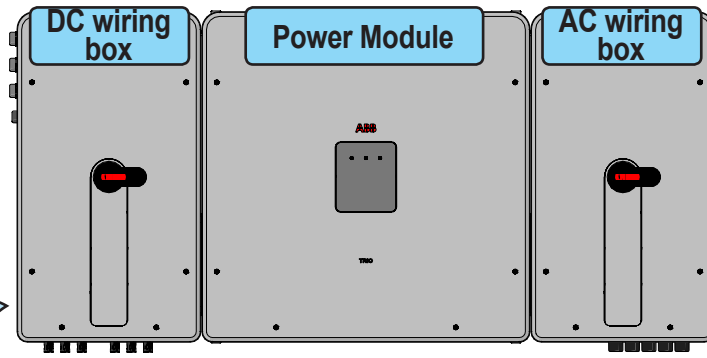
-20 to + 60 °C
-4 to +140 °F

ABB 1 4 Made in Italy

www.abb.com/solar

POWER MODULE
(COMPONENT OF MODEL TRIO-60.0-TL-OUTD-480)

MODEL:
TRIO-60.0-TL-OUTD-480-POWER MOD 2

SOLAR INVERTER
MODEL:
TRIO-60.0-TL-OUTD-480

V _{dc} max	1000 V	V _{ac}	480 V 3Ø
V _{dc} MPP	360 - 950 V	f _r	50 / 60 Hz
V _{dc} , Full Power	570 - 800 V	P _{ac} (cosφ = 1)	60000 W
I _{dc} max	108 A	P _{ac} (cosφ = 0.9)	54000 W
I _{ac} max	160 A	I _{ac} max	77 A

-20 to + 60 °C
-4 to + 140 °F

ABB 1 4 Made in Italy

www.abb.com/solar

AC WIRING BOX
(COMPONENT OF MODEL TRIO-60.0-TL-OUTD-480)

MODEL:
ACWB-TRIO-60.0-TL-OUTD-480 2

-20 to + 60 °C
-4 to +140 °F

ABB 1 4 Made in Italy

www.abb.com/solar

DC WIRING BOX
(COMPONENT OF MODEL TRIO-60.0-TL-OUTD-480)

MODEL:
DCWB-S-TRIO-60.0-TL-OUTD-480 2

-20 to + 60 °C
-4 to +140 °F

The approval label contains the following information:

1. Manufacturer
2. Model
3. Rating data
4. Certification marks

ABB 1 4 Made in Italy

www.abb.com/solar

AC WIRING BOX
(COMPONENT OF MODEL TRIO-60.0-TL-OUTD-480)

MODEL:
ACWB-S-TRIO-60.0-TL-OUTD-480 2

-20 to + 60 °C
-4 to +140 °F

ABB 1 4 Made in Italy

www.abb.com/solar

DC WIRING BOX
(COMPONENT OF MODEL TRIO-60.0-TL-OUTD-480)

MODEL:
DCWB-SX-TRIO-60.0-TL-OUTD-480 2

-20 to + 60 °C
-4 to +140 °F

ABB 1 4 Made in Italy

www.abb.com/solar

AC WIRING BOX
(COMPONENT OF MODEL TRIO-60.0-TL-OUTD-480)

MODEL:
ACWB-SX-TRIO-60.0-TL-OUTD-480 2





-20 to + 60 °C
-4 to +140 °F



The labels are NOT to be hidden by foreign objects and parts (rags, boxes, equipment, etc.); they must be regularly cleaned and always kept in sight.

In addition to the label showing the inverter data, there are also additional identification labels for the power module and the 2 wiring boxes.

The labels displays the following information:

MODEL NAME		• Inverter or wiring box model
		• Inverter Part Number
	P/N: P/P/P/P/P/P/P/P/P/P	• Inverter/wiring box Serial Number consisting of: - YY = Year of manufacture - WW = Week of manufacture - SSSSSS = sequential number
	WO: XXXXXXXX	
	SO: SXXXXXXXX Q1	• Week/Year of manufacture
	SN: YYWWSSSSSS WK: WWYY	



The officially required information is located on the approval label. The identification label is an accessory label which shows the information necessary for the identification and characterisation of the inverter by ABB.



The labels are NOT to be hidden by foreign objects and parts (rags, boxes, equipment, etc.); they must be regularly cleaned and always kept in sight.

Models and range of equipment



The choice of the inverter model must be made by a qualified technician who knows about the installation conditions, the devices that will be installed outside the inverter and possible integration with an existing system.

In the following table are indicated the available models of the power module and for the DC or AC wiring box.

“DC Wiring Box” Model Number

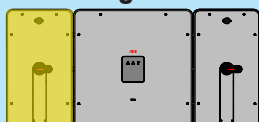

Description

DCWB-TRIO-50.0-TL-OUTD	DC input connectors with screw terminal block
DCWB-TRIO-60.0-TL-OUTD	
DCWB-S-TRIO-50.0-TL-OUTD	DC input connectors with screw terminal block + DC disconnect switch
DCWB-S-TRIO-60.0-TL-OUTD	
DCWB-SX-TRIO-50.0-TL-OUTD/12 INPUTS	Input with 12 quick fit connectors pairs + String fuses + DC disconnect switch + DC overvoltage surge arresters type 2
DCWB-SX-TRIO-50.0-TL-OUTD/16 INPUTS	
DCWB-SX-TRIO-60.0-TL-OUTD/16 INPUTS	Input with 16 quick fit connectors pairs + String fuses + DC disconnect switch + DC overvoltage surge arresters type 2
DCWB-SY-TRIO-50.0-TL-OUTD	
DCWB-SY-TRIO-50.0-TL-OUTD	Input with 12 quick fit connectors pairs + String fuses + DC disconnect switch + DC overvoltage surge arresters type 1+2

“AC Wiring Box” Model Number

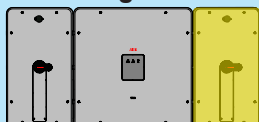

Description

ACWB-TRIO-50.0-TL-OUTD	AC output connectors with screw terminal block
ACWB-TRIO-60.0-TL-OUTD	
ACWB-S-TRIO-50.0-TL-OUTD	AC output connectors with screw terminal block + AC disconnect switch
ACWB-S-TRIO-60.0-TL-OUTD	
ACWB-SX-TRIO-50.0-TL-OUTD	AC output connectors with screw terminal block + AC disconnect switch + AC overvoltage surge arresters type 2
ACWB-SX-TRIO-60.0-TL-OUTD	

“Power module” Model Number

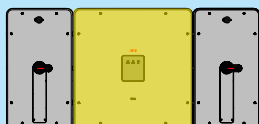

Description

TRIO-50.0-TL-OUTD-POWER MODULE	50.0 kW power module
TRIO-60.0-TL-OUTD-POWER MODULE	60.0 kW power module

“Bracket” Model Number

Description

TRIO-50.0-BRACKET-VERTICAL	Wall mounting bracket; 90 to 16 degrees from horizontal
TRIO-50.0-BRACKET-HORIZONTAL	Horizontal mounting bracket; 15 to 0 degrees horizontal

List of main reference components

- | | | |
|------------------------------------|-----------------------------------|--|
| 01 assembly bracket | 14 DC disconnect switch | 28 top stops |
| 02 DC wiring box | 15 DC overvoltage surge arresters | 29 conductor springs |
| 03 power module | 16 single AC cable gland | 30 individual AC cable glands (not supplied) |
| 04 interface connector cap | 17 AC output terminal block | 31 cap deposit box |
| 05 AC wiring box | 18 AC overvoltage surge arresters | 32 ground connection brackets |
| 06 handles | 19 input connectors (MPPT) | 33 WiFi antenna M20 cap |
| 07 metal locking forks | 20 ground protection terminal | 34 PG 21 cable gland |
| 08 front cover | 21 anti-condensation valve | 35 PG 16 cable gland |
| 09 communication and control board | 22 negative (-) side string fuses | 36 AC disconnect switch |
| 10 positive (+) side string fuses | 23 interface connector | 37 ground brackets fitting points |
| 11 DC cable glands | 24 spacers | 38 plastic locking forks |
| 12 AC filter board | 26 heat sink | |
| 13 DC input terminal block | 27 rear pins | |

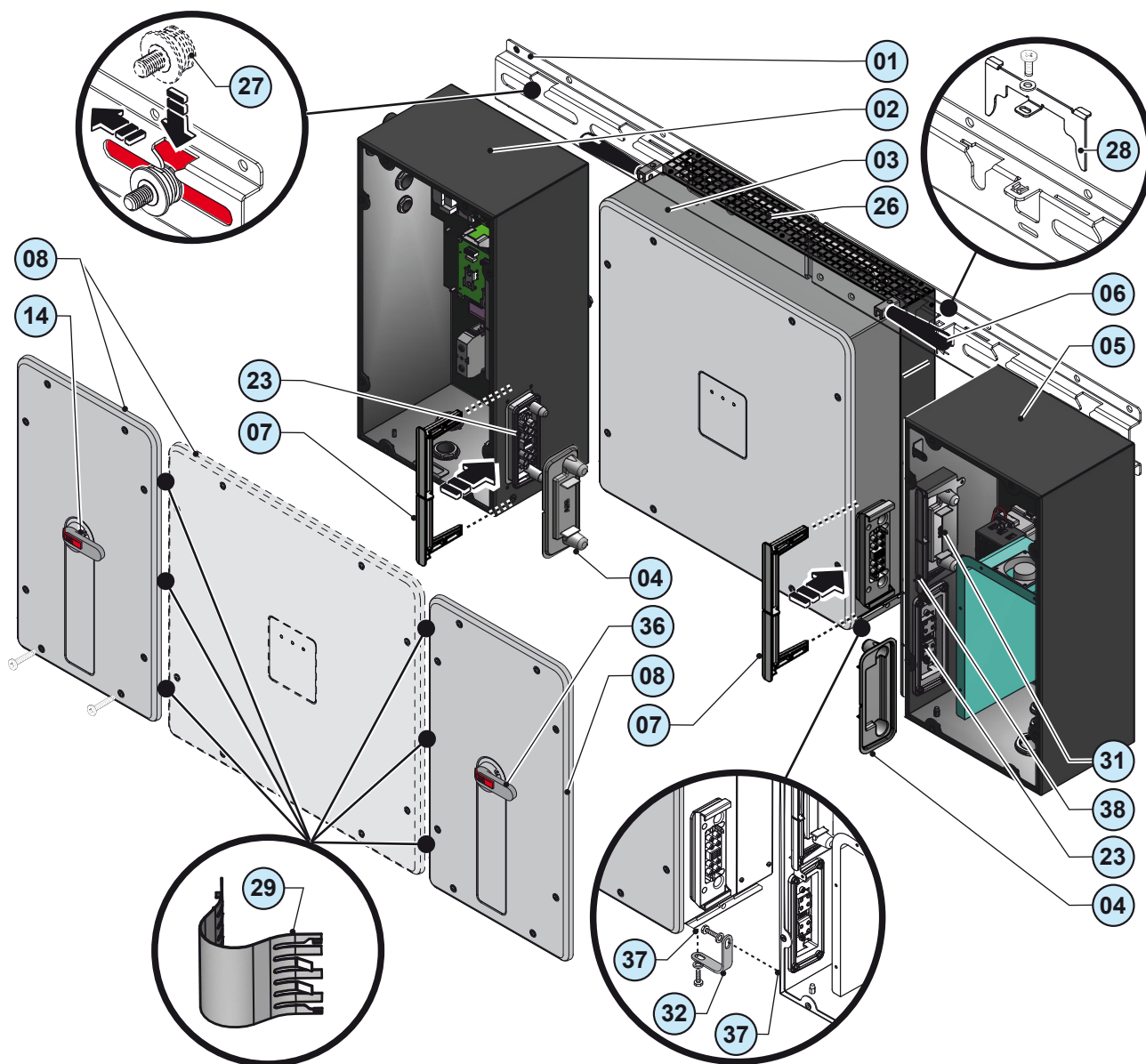

DC wiring box Standard / -S / -SX / -SY version

- | | | |
|------------------------------------|--|-----------------------------------|
| 01 assembly bracket | 24 spacers | 32 ground connection brackets |
| 02 DC wiring box | 26 heat sink | 33 WiFi antenna M20 cap |
| 03 power module | 27 rear pins | 34 PG 21 cable gland |
| 04 interface connector cap | 28 top stops | 35 PG 16 cable gland |
| 05 AC wiring box | 29 conductor springs | 36 AC disconnect switch |
| 06 handles | 30 individual AC cable glands (not supplied) | 37 ground brackets fitting points |
| 07 metal locking forks | 31 cap deposit box | 38 plastic locking forks |
| 08 front cover | | |
| 09 communication and control board | | |
| 10 positive (+) side string fuses | | |
| 11 DC cable glands | | |
| 12 AC filter board | | |
| 13 DC input terminal block | | |
| 14 DC disconnect switch | | |
| 15 DC overvoltage surge arresters | | |
| 16 single AC cable gland | | |
| 17 AC output terminal block | | |
| 18 AC overvoltage surge arresters | | |
| 19 input connectors (MPPT) | | |
| 20 ground protection terminal | | |
| 21 anti-condensation valve | | |
| 22 negative (-) side string fuses | | |
| 23 interface connector | | |

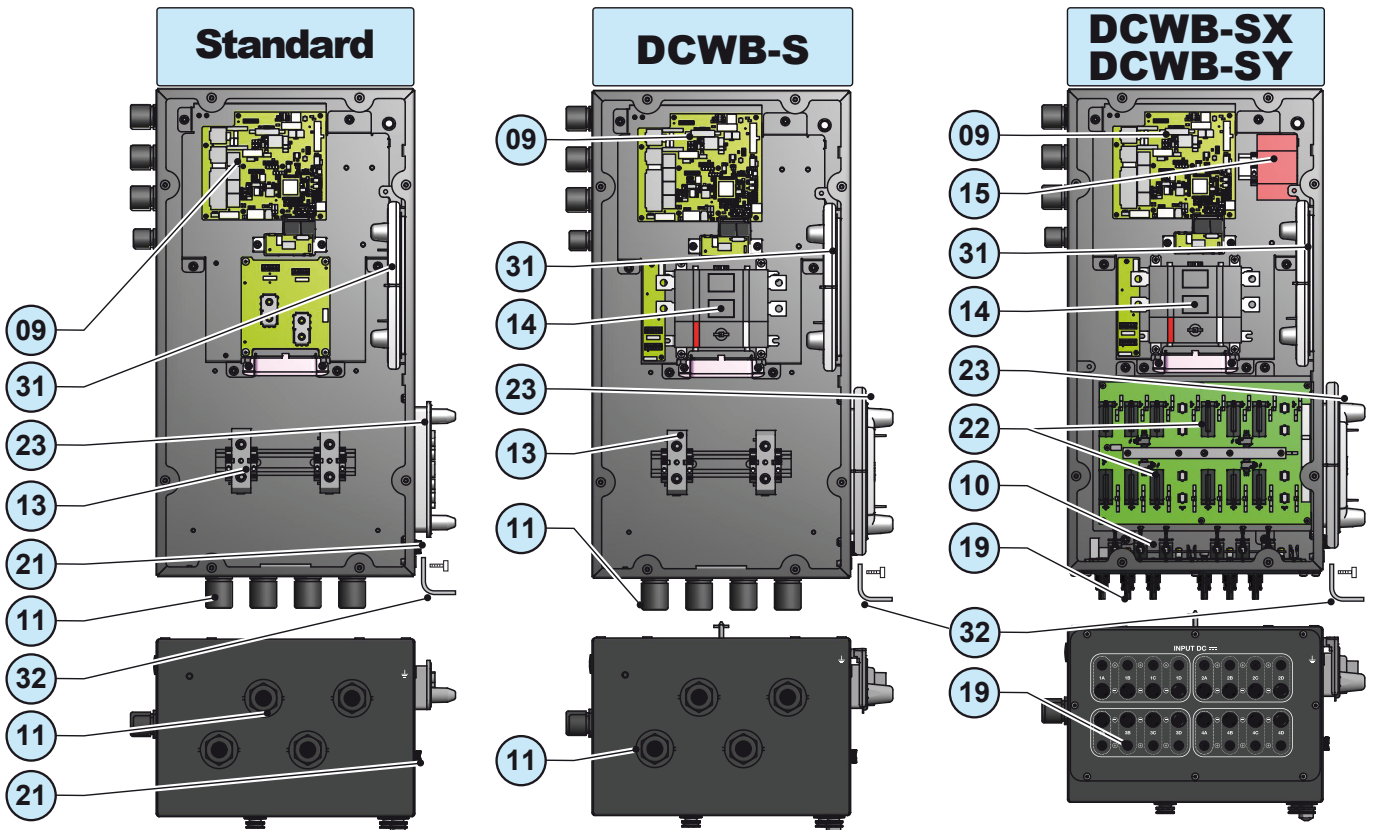
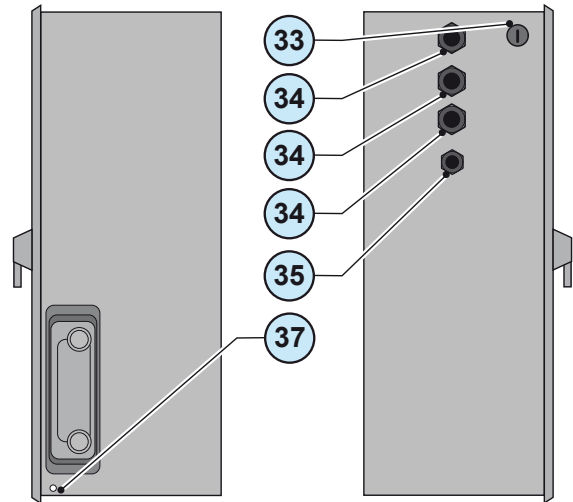

The DCWB-SY is not available for TRIO-60.0-TL-OUTD-480 model

AC wiring box Standard -S / -SX version

- | | |
|------------------------------------|--|
| 01 assembly bracket | 20 ground protection terminal |
| 02 DC wiring box | 21 anti-condensation valve |
| 03 power module | 22 negative (-) side string fuses |
| 04 interface connector cap | 23 interface connector |
| 05 AC wiring box | 24 spacers |
| 06 handles | 26 heat sink |
| 07 metal locking forks | 27 rear pins |
| 08 front cover | 28 top stops |
| 09 communication and control board | 29 conductor springs |
| 10 positive (+) side string fuses | 30 individual AC cable glands (not supplied) |
| 11 DC cable glands | 31 cap deposit box |
| 12 AC filter board | 32 ground connection brackets |
| 13 DC input terminal block | 33 WiFi antenna M20 cap |
| 14 DC disconnect switch | 34 PG 21 cable gland |
| 15 DC overvoltage surge arresters | 35 PG 16 cable gland |
| 16 single AC cable gland | 36 AC disconnect switch |
| 17 AC output terminal block | 37 ground brackets fitting points |
| 18 AC overvoltage surge arresters | 38 plastic locking forks |
| 19 input connectors (MPPT) | |

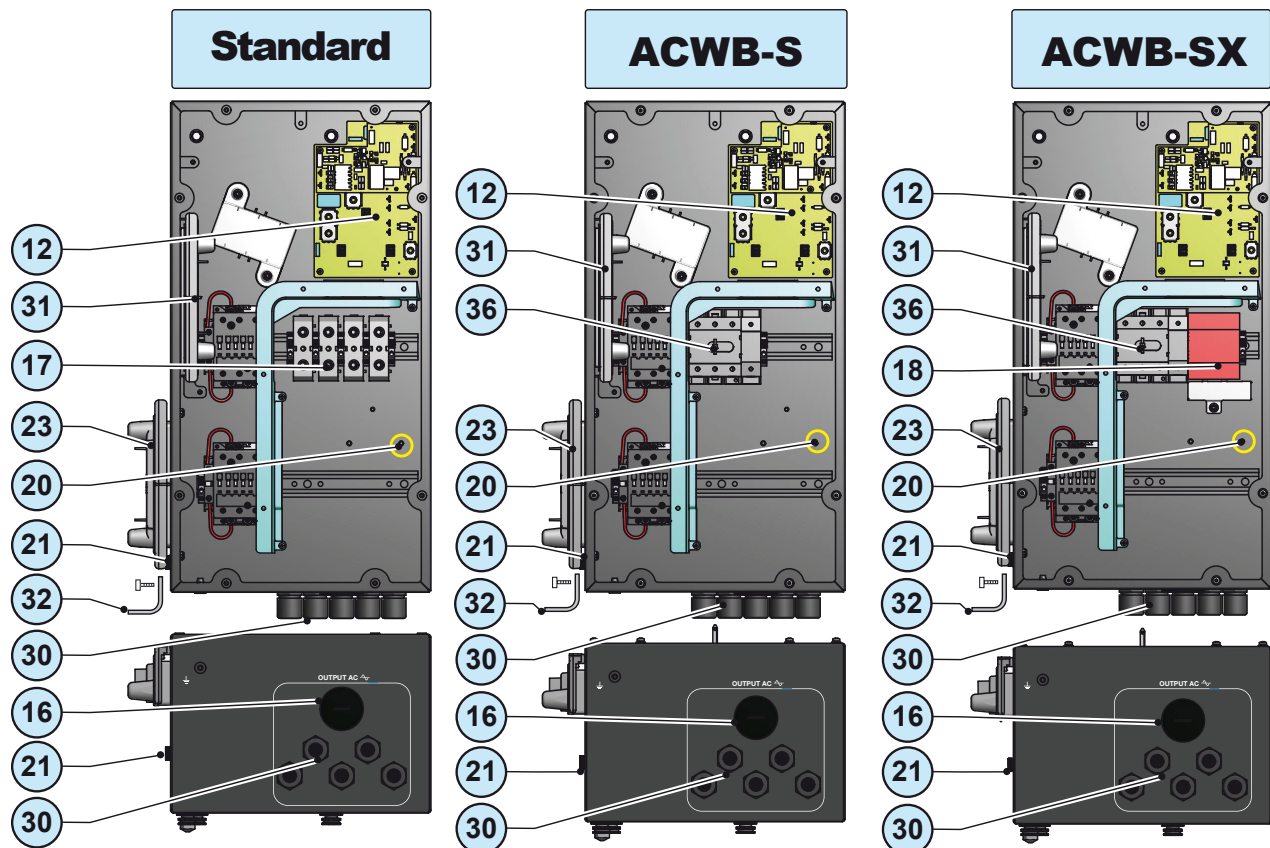
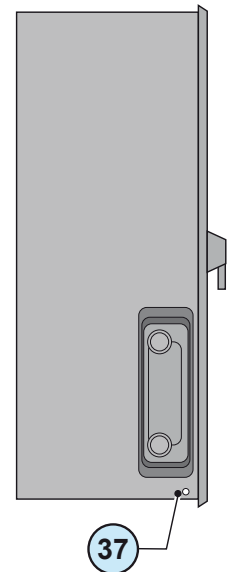

Principal wiring box components

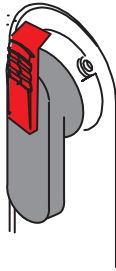

AC line disconnect switch ³⁶
TRIO-50.0 wiring box -S / -SX
 Model: OT100F4N2 or equivalent

AC disconnect switch		
Voltage	Utilisation category	Current
380-415Vac	AC22A	100A
380-415Vac	AC23A	80A

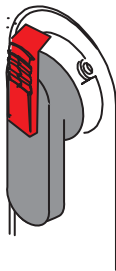

AC line disconnect switch ³⁶
TRIO-60.0 wiring box -S / -SX
 Model: OT100F4N2 or equivalent

AC disconnect switch		
Voltage	Utilisation category	Current
500Vac	AC22A	100A
500Vac	AC23A	60A

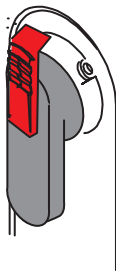

DC line disconnect switch ¹⁴
TRIO-50.0/60.0 wiring box -S / -SX/ -SY
 Model: OTDC200U02 or equivalent

DC disconnect switch		
Voltage	Utilisation category	Current
1000Vdc	UL98B	200A

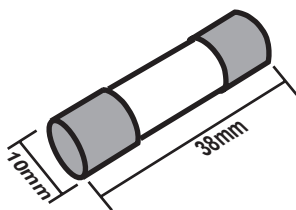

String fuses ²²
TRIO-50.0/60.0 wiring box -SX/ -SY

The standard string protection fuses installed on the inverter have the following features:

Voltage	Rating	Type
1000Vdc	15 A (Max. Rating 20A)	gPV



DC overvoltage surge arresters ¹⁵ class 2
TRIO-50.0/60.0 per wiring box -SX

The DC overvoltage surge arresters installed in this wiring box model are of the Dehn DG M YPV SCI 1000 FM (6 cartridges) type or Dehn DG M PV2 SCI 1000 FM (5 cartridges) type. The surge arresters consist of interchangeable cartridges type DG MOD PV SCI 500 (A) and DG MOD PV 500 (B). In the event of damage to the surge arresters caused by atmospheric agents, spare part kits may be ordered quoting code KIT SURGE DC SIDE TRIO.

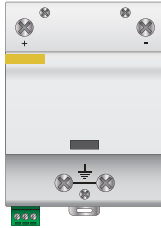

**DC overvoltage surge arresters 15 class 1+2
TRIO-50.0 wiring box -SY**

The DC overvoltage surge arresters installed in this wiring box model are of the CITEL DS60VGPV-1000 type. In the event of damage to the surge arresters caused by atmospheric agents, the protection device must be replaced as it is not equipped with interchangeable cartridges.

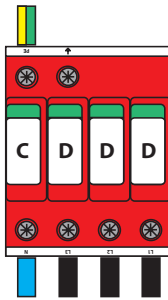

**AC overvoltage surge arresters 18 class 2
TRIO-50.0/60.0 wiring box -SX**

The AC surge arresters installed are type Dehn DG M TT 275 FM (or equivalent), composed of four interchangeable cartridges, type DG MOD 275 (D) and DG MOD NPE (C).

In the event of damage to the surge arresters caused by atmospheric agents, spare part kits may be ordered quoting code KIT SURGE AC SIDE TRIO



In the event of damage to the surge arresters caused by atmospheric agents, spare part kits are available.

Characteristics and technical data

Table: Technical Data	TRIO-50.0-TL-OUTD	TRIO-60.0-TL-OUTD-480
Input		
Absolute Maximum Input Voltage (V _{max,abs})	1000 V	
Input start-up voltage (V _{start})	420...700 V (default 420 V)	420...700 V (default 500)
Input operating interval (V _{dcmín...V_{dcmáx}})	0,7xV _{start} ...950 V (min 300 V)	0.7xV _{start} ...950 V (min 360 V)
Rated Input Voltage (V _{dcr})	610 Vdc	720 Vdc
Input Nominal Power(P _{dcr})	52000 W	61800 W
Number of Independent MPPT	1	
MPPT DC Voltage Range (V _{MPPTmin} ... V _{MPPTmax}) to P _{acr}	480-800 V	570-800 Vdc
Maximum DC Input Current (I _{dcmáx})	110 A	108A
Maximum Return current (AC side vs DC side)	Negligible in normal operating conditions ⁽³⁾	
Maximum short circuit current (I _{scmáx})	160 A	
Maximum current for each quick fit connector (-SX / -SY version)	13.5A for 16 DC inputs wiring box version ⁽⁵⁾	
Type of Input DC Connectors	Screw terminal block max. cross-section 95mm ² (Standard / -S versions) PV quick fit connector ⁽⁴⁾ (-SX and -SY ⁽⁷⁾ version)	
Type of photovoltaic panels that can be connected at input according to IEC 61730	Class A	
Input protection		
Reverse Polarity Protection	Yes, from current limited source	
Input Overvoltage protection - Varistors	Yes, 2	
Overvoltage protection - Modular surge arrester	-SX: Classe II ; -SY ⁽⁷⁾ : Classe I+II	
Insulation Check	Complying with the local standard	
Characteristics of DC disconnect switch (versions with DC disconnect switch)	200 A / 1000 V	
String fuses (-SX/-SY ⁽⁶⁾ versions)	15A (gPV / 1000Vdc / Max. installable size 20A)	
Output		
AC Connection to the grid	3Ø grounded WYE system only, 3W + GND (no N connection) or 4W + GND (with N connection)	
Nominal AC Output Power (P _{acr} @cosφ=1)	50000 W	60000 W
Maximum AC Output Power (P _{acmáx} @cosφ=1)	50000 W	60000 W
Maximum apparent Output power (S _{máx})	50000 VA	60000 VA
Rated AC Output Voltage (V _{acr})	400 V	480 V
Output voltage range (V _{acmín...V_{acmáx}})	320...480 V ⁽¹⁾	384...571 V ⁽¹⁾
Maximum output current (I _{acmáx})	77 A	
Contribution to short-circuit current	92 A	
Rated Output Frequency (fr)	50 Hz / 60 Hz	
Output Frequency Range (f _{mín...f_{máx}})	47...53 Hz / 57...63 Hz ⁽²⁾	
Nominal power factor and setting interval	> 0.995, 0...1 inductive/capacitive with maximum S _{máx}	
Total harmonic distortion of current	<3%	
Maximum AC cable section allowed	95 mm ² copper/aluminum (Standard version) 70 mm ² copper (-S / -SX versions) 150 mm ² copper/aluminum with TRIO-WIRING-KIT (all versions)	
AC Connections Type	Screw terminal block - single AC cable gland PG42 ⁽⁶⁾ (default configuration) or 5 individual AC cable glands (not supplied)	
Output protection		
Anti-islanding Protection	Complying with the local standard (active frequency drift combined with RoCoF techniques)	
Maximum external AC overcurrent protection	100 A	
Output overvoltage protection - Varistors	Yes, 4	
Output overvoltage protection - Modular surge arrester (-SX version)	4, Classe II	



Table: Technical Data		TRIO-50.0-TL-OUTD	TRIO-60.0-TL-OUTD-480
Operating performance			
Maximum Efficiency (η_{max})		98.30%	98.50%
Weighted Efficiency (EURO/CEC)		98.0% / -	98.0% / -
Communication			
Remote Monitoring		VSN300 Wifi Logger Card (opt.), VSN700 Data Logger (opt.)	
Wireless local monitoring		VSN300 Wifi Logger Card (opt.)	
User Interface		LEDs	
Available ports		2 (RS485)	
Environmental			
Ambient temperature range		-25...+60°C / -13...140°F with derating over 50°C / 122°F	-25...+60°C / -13...140°F with derating over 45°C / 113°F
Storage temperature		-40°C...+85°C / -40°F...185°F	
Relative Humidity		4...100 % with condensation	
Typical noise emission pressure		75 dB(A) @ 1 m	
Maximum operating altitude without derating		2000 m / 6560 ft	
Environmental pollution degree classification for external environments		3	
Environmental class		Outdoor	
Physical			
Environmental Protection Rating		IP 65 (IP54 for the cooling section)	
Cooling System		Forced air	
Dimensions (H x W x D)		725 mm x 1491 mm x 315 mm / 28.5" x 58.7" x 12.4"	
Weight		95 kg total 66 kg power module, 15 kg for AC wiring box (full optional), 14 kg for DC wiring box (full optional)	
Assembly System		Wall bracket or horizontal support	
Overvoltage rating as per IEC 62109-1		II (DC input)	III (AC output)
Safety			
Safety class		I	
Insulation Level		Without transformer (TL)	
CE Marking		CE	
Safety and EMC Standards		IEC/EN 62109-1, IEC/EN 62109-2, EN 61000-6-2, EN 61000-6-3, EN 61000-3-11, EN 61000-3-12	IEC/EN 62109-1, IEC/EN 62109-2, EN 61000-6-1, EN 61000-6-2, EN 61000-6-3, EN 61000-6-4, EN 61000-3-11, EN 61000-3-12
Grid standard (check the availability with your sales channel)		CEI 0-21, CEI 0-16, DIN V VDE V 0126-1-1, VDE-AR-N 4105, G59/3, EN 50438 (not for all national appendices), RD 1699, RD 413, RD 661, P.O. 12.3, AS 4777, BDEW, NRS-097-2-1, MEA, PEA, IEC 61727, IEC 60068, IEC 61683, VFR-2014, IEC 62116	CEI 0-16, DIN V VDE 0126-1-1, G59/3, BDEW, IEC 61727, IEC 60068, IEC 61683, VFR-2014, IEC 62116, IRR-DCC-MV (Jordan), UTE C15-7-712-1
Accessories			
TRIO-50.0/60.0-GROUNDING KIT		Allows to connect the negative input pole to ground	
TRIO-AC-WIRING-KIT		Allows to connect the AC output cables, copper or aluminum, with cross section up to 150mm ²	

- The output voltage range may vary according to the grid standard of the country of installation
- The output frequency range may vary according to the grid standard of the country of installation
- In the event of a fault, limited by the external protection envisaged on the AC circuit
- Please refer to the document "String inverters – Product manual appendix" available at www.abb.com/solarinverters for information on the quick-fit connector brand and model used in the inverter.
- The maximum accepted current for each group of inputs (3 or 4 strings based on the DC wiring box model) is 54A
- PG42 reduced cable entry from 25 to 31mm
- The DCWB-SY is not available for TRIO-60.0-TL-OUTD-480 model

Note. Features not specifically mentioned in this data sheet are not included in the product

Tightening torques

To maintain the IP65 protection of the system and for optimal installation, the following tightening torques must be used:

DC Wiring box ②	
Service cable gland ③④ PG 21	5.0 Nm
Service cable gland ③⑤ PG 16	2.7 Nm
DC cable glands ①① M32 (only Standard / -S versions)	8.0 Nm
Front cover ⑧⑧	2.4 Nm
DC input terminal block ⑬⑬ 95 mm ² (Standard / -S version)	20 Nm
Quick fit connectors MC4 or Weidmuller (-SX/ -SY version)	2.5 Nm
Mounting screws for earth connection brackets ③②	11Nm
Power module ③③	
Mounting screws for earth connection brackets ③②	11Nm
AC Wiring box ⑤⑤	
Single AC cable gland ①⑥ PG 42 (reduced cable entry)	10 Nm
Individual AC cable glands ③⑩ M32 (not supplied)	8.0 Nm
Front cover ⑧⑧	2.4 Nm
AC output terminal block ①⑦ 95 mm ² (Standard version)	20 Nm
AC disconnect switch terminal block ③⑥ 70 mm ² (-S / -SX version)	6 Nm
Mounting screws for earth connection brackets ③②	11Nm

Cable gland clamping range

DC Wiring box ②	
Service cable gland ③④ PG 21	13...18mm
Service cable gland ③⑤ PG 16	10...14mm
DC cable glands ①① M32 (Standard / -S versions)	13...21mm
AC Wiring box ⑤⑤	
Single AC cable gland ①⑥ PG 42 (reduced cable entry)	25...31mm
Individual AC cable glands ③⑩ M32 (not supplied)	13...21mm

Overall dimensions

The overall dimensions are expressed in millimetres and include the vertical or horizontal wall installation bracket.

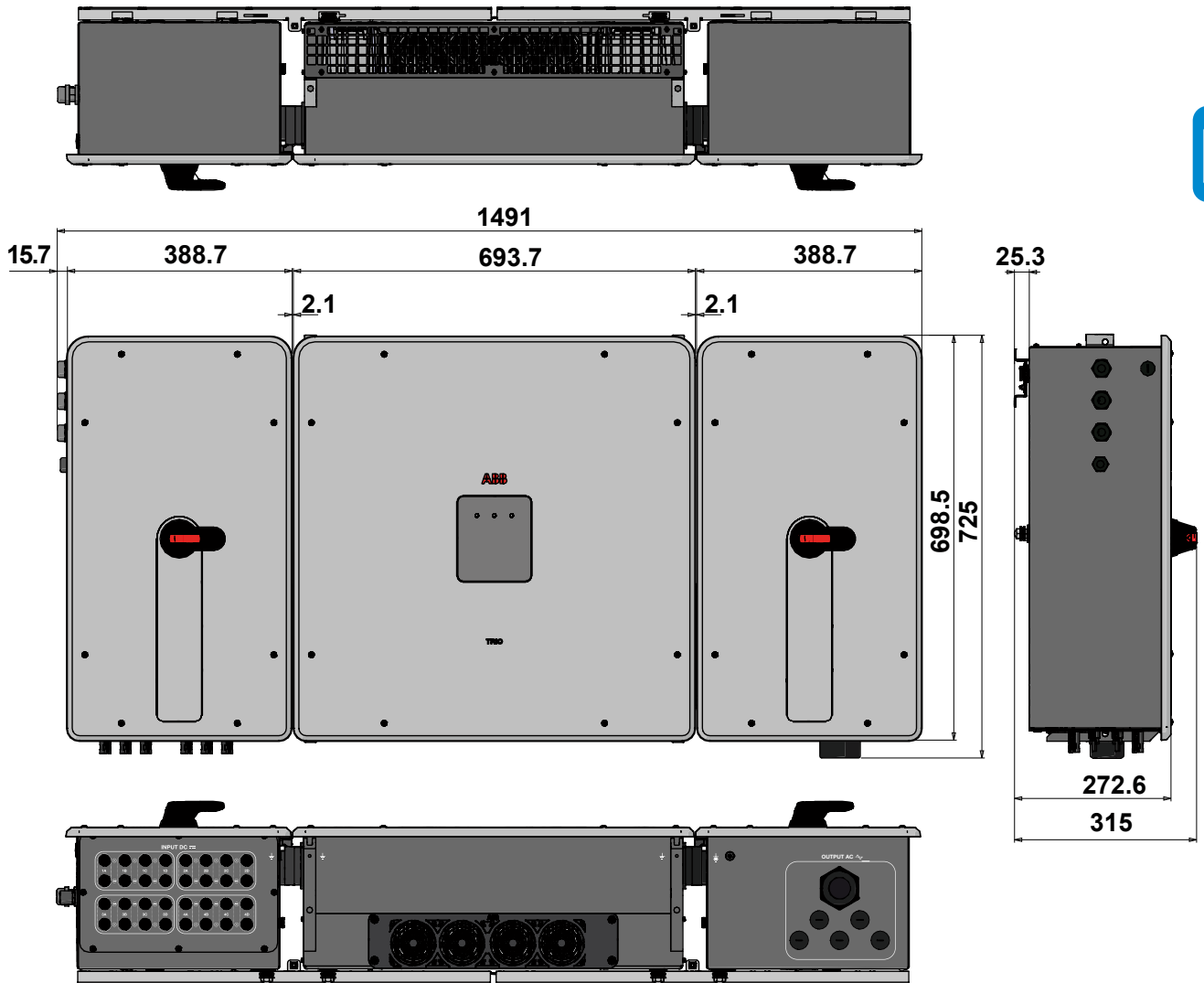

Dimensions of vertical wall assembly bracket.

The dimensions of the wall mounting bracket are expressed in millimetres.

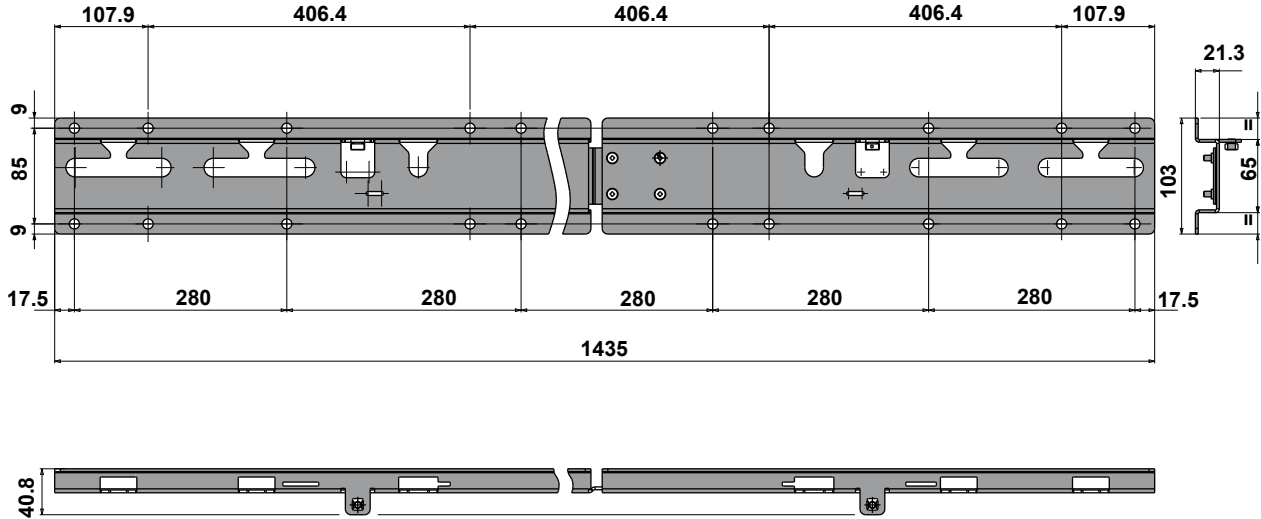

Horizontal wall assembly bracket.

The dimensions of the wall mounting bracket are expressed in millimetres.

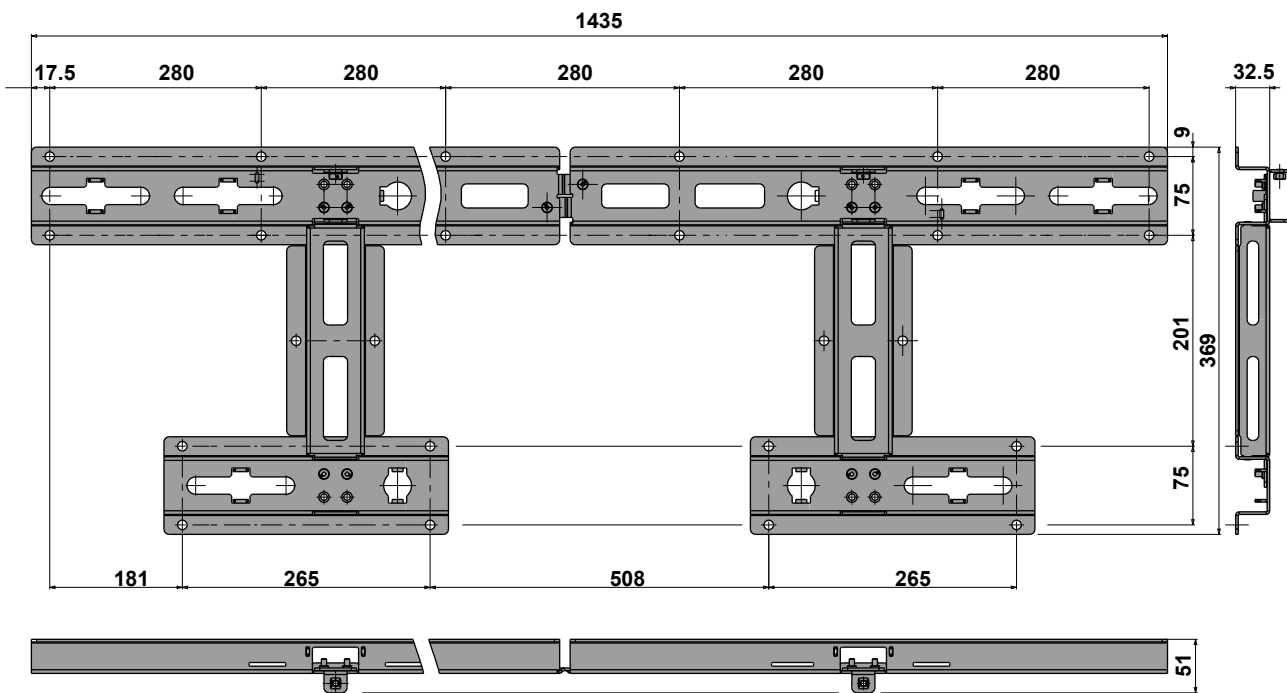

Efficiency curves

The equipment was designed considering current energy conservation standards, to avoid waste and unnecessary leakage.

Graphs of the efficiency curves of all models of inverter described in this manual are shown below.

The efficiency curves are linked to technical parameters that are continually being developed and improved and should therefore be considered approximate.



TRIO-50.0-TL-OUTD



TRIO-60.0-TL-OUTD-480

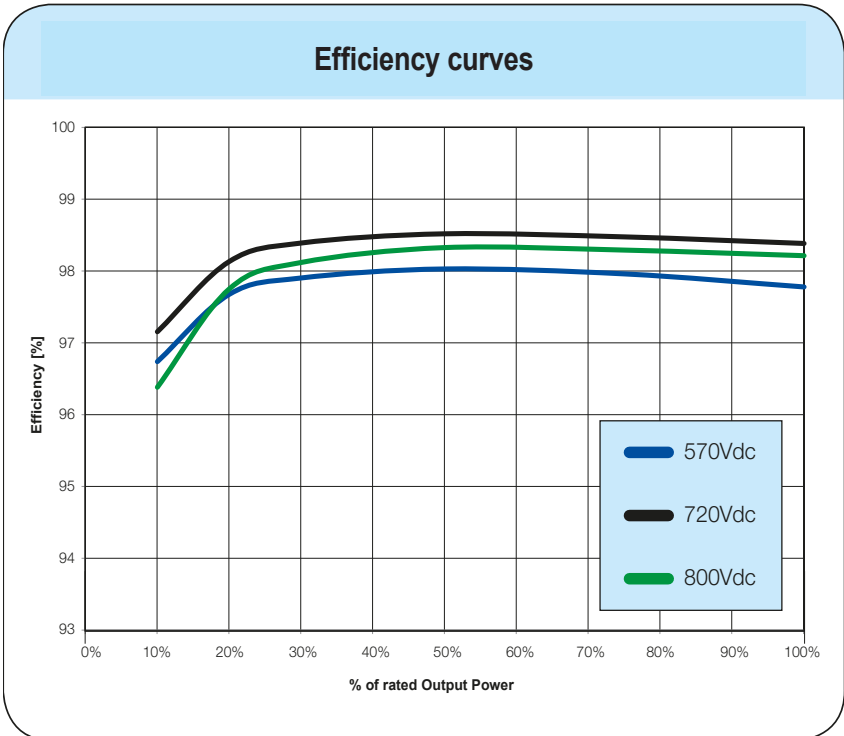

Power limitation (Power Derating)

In order to allow inverter operation in safe thermal and electrical conditions, the unit automatically reduces the value of the power fed into the grid.

Power limiting may occur due to:

- Adverse environmental conditions (thermal derating)
- Percentage of output power (value set by the user)
- Grid voltage over frequency (mode set by user)
- Grid overvoltage $U > 10\text{min Der.}$ (enabling carried out by user)
- Anti-islanding
- Grid under voltage
- Input voltage values too high.
- High input current values.



Power reduction due to environmental conditions

The power reduction value and the inverter temperature at which it occurs depend on the ambient temperature and on many operating parameters.

Example: input voltage, grid voltage and power available from the photovoltaic field.

The inverter can therefore reduce the power during certain periods of the day according to the value of these parameters.

In any case, the inverter guarantees the maximum output power even at high temperatures, provided the sun is not shining directly on it.

TRIO-50.0-TL-OUTD
TRIO-60.0-TL-OUTD-480

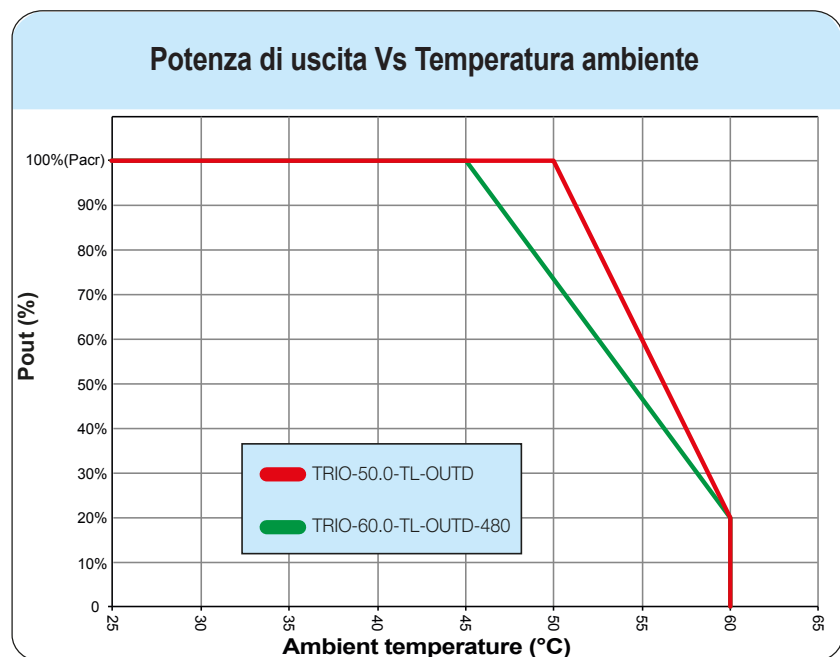

Power reduction due to the input voltage

The reduction of the power supplied where the DC input voltage values are too high or too low is adjusted automatically.

TRIO-50.0-TL-OUTD
TRIO-60.0-TL-OUTD-480

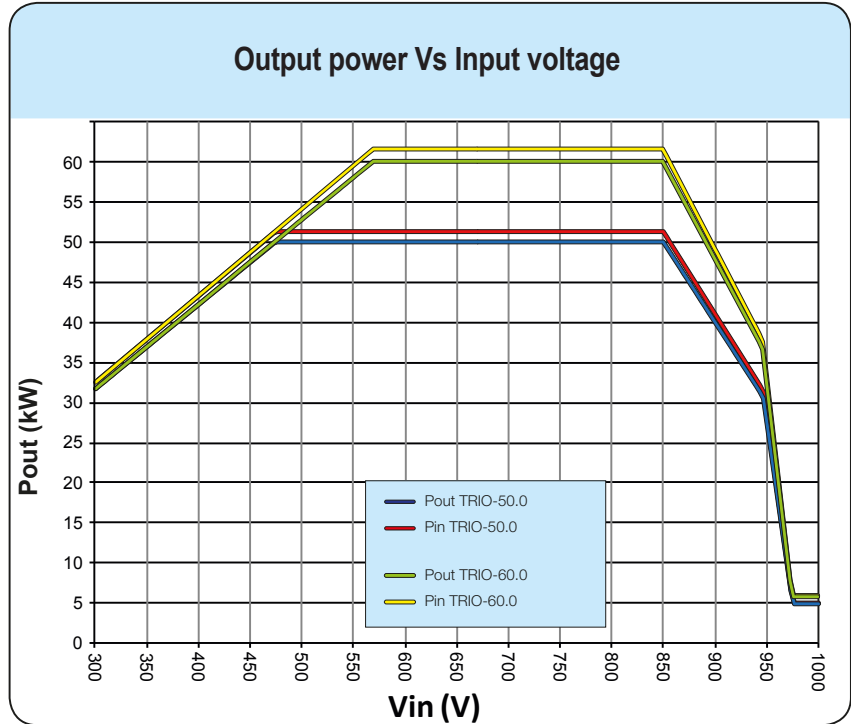

Power reduction due to the grid voltage

The reduction of the power supplied where the grid voltage values are too high or too low is adjusted automatically.

TRIO-50.0-TL-OUTD
TRIO-60.0-TL-OUTD-480

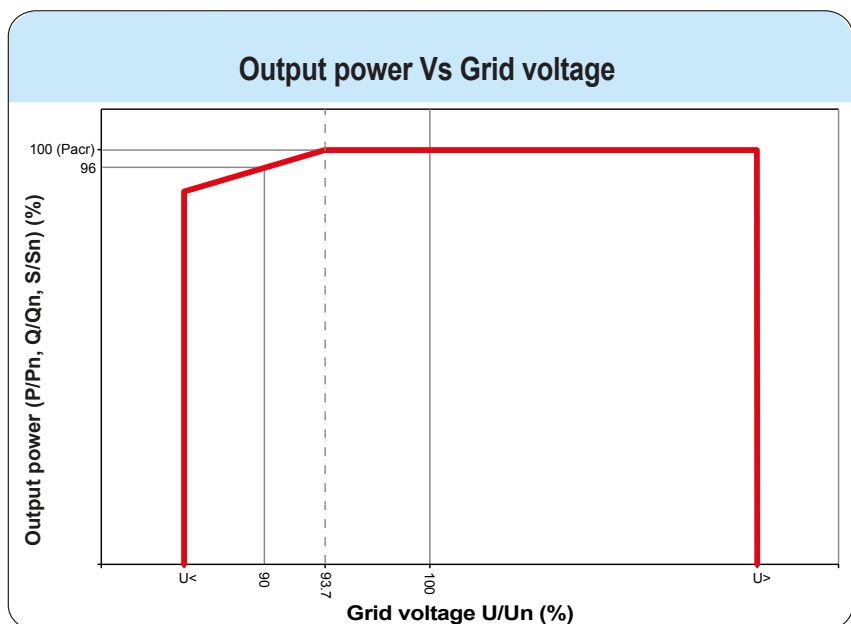

The $U<$ and $U>$ values could change based on the grid country standard selection

P - Q curve capability

Based on the standard network on the country the capability of P-Q curve can be reduced.

Conditions:

TRIO-50.0-TL-OUTD

- Ambient temperature 50 °C
- Rated output voltage (Un) 400Vac
- Rated active power (Pn) 50kW
- Nominal apparent power (Sn) 50kVA
- Rated reactive power (Qn) 50kVAR
- Cos -0 ... 1 ... 0 +
- Capability with grid voltage between 0.937xUn ... 1.1xUn

TRIO-60.0-TL-OUTD-480

- Ambient temperature 45 °C
- Rated output voltage (Unom) 480Vac
- Rated active power (Pnom) 60kW
- Nominal apparent power (Snom) 60kVA
- Rated reactive power (Qnom) 60kVAR
- Cos -0 ... 1 ... 0 +
- Capability with grid voltage between 0.937xUnom ... 1.1xUnom

TRIO-50.0-TL-OUTD
TRIO-60.0-TL-OUTD-480

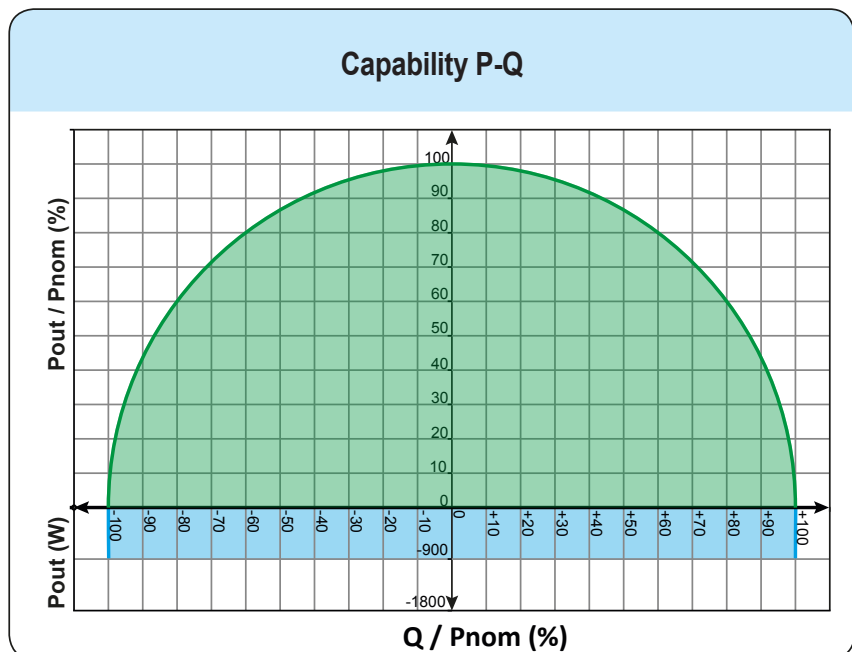

Characteristics of a photovoltaic generator

A PV generator consists of an assembly of photovoltaic panels that transform solar radiation into DC electrical energy and can be made up of:

Strings: X number of PV panels connected in series

Array: group of X strings connected in parallel

Strings and Arrays

In order to considerably reduce the cost of installing a photovoltaic system, mainly associated with the problem of wiring on the DC side of the inverter and subsequent distribution on the AC side, the string technology has been developed. A photovoltaic panel consists of many photovoltaic cells mounted on the same support.

- A string consists of a certain number of panels connected in series.
- An array consists of two or more strings connected in parallel.

Large photovoltaic systems can be made up of several arrays, connected to one or more inverters.

By maximizing the number of panels inserted into each string, it is possible to reduce the cost and complexity of the connection system of the photovoltaic system.

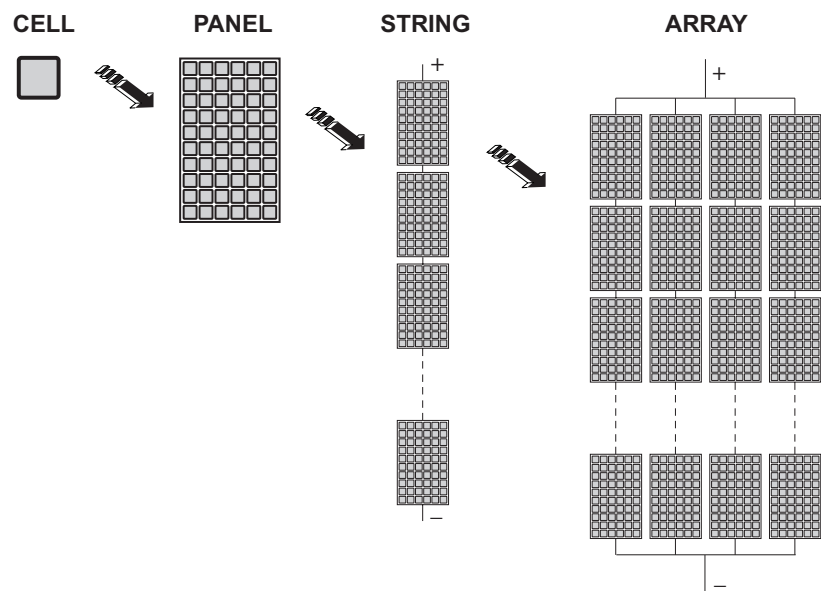

The current of each array must fall within the limits of the inverter.



To work, the inverter must be connected to the national electricity grid since its operation can be equated to a current generator that supplies power in parallel with the grid voltage. That is why inverters cannot support the grid voltage (islanding).

Description of the equipment



This equipment is a string inverter which converts the direct current of a photovoltaic generator into alternating current and feeds it into the public distribution grid.

Photovoltaic panels convert solar radiation into “DC” electrical energy (via a photovoltaic field, also called PV generator); in order to use it, it is transformed into “AC” alternate current. This conversion, known as inversion from DC to AC, is done in an efficient way by the ABB inverters, without using any rotary elements, rather only via static electronic systems. In order to allow inverter operation in safe thermal and electrical conditions, the unit automatically reduces the value of the power fed into the grid under adverse environmental conditions or unsuitable input voltage values.

When connected in parallel with the grid, the alternating current from the inverter flows directly into the domestic or industrial distribution circuit, which is in turn connected to the public distribution grid.

This way the solar energy system compensates for the energy drawn from the utilities connected to the grid to which it is linked.

When the photovoltaic system is not generating sufficient energy, the power required to ensure proper operation of connected loads is taken from the public distribution grid. While if too much energy is produced, it is directly fed to the grid, thus becoming available to other users.

According to national and local standards and regulations the produced energy can be sold to the grid or credited to the user against future consumption, thus granting a great saving of money.

Operating diagram

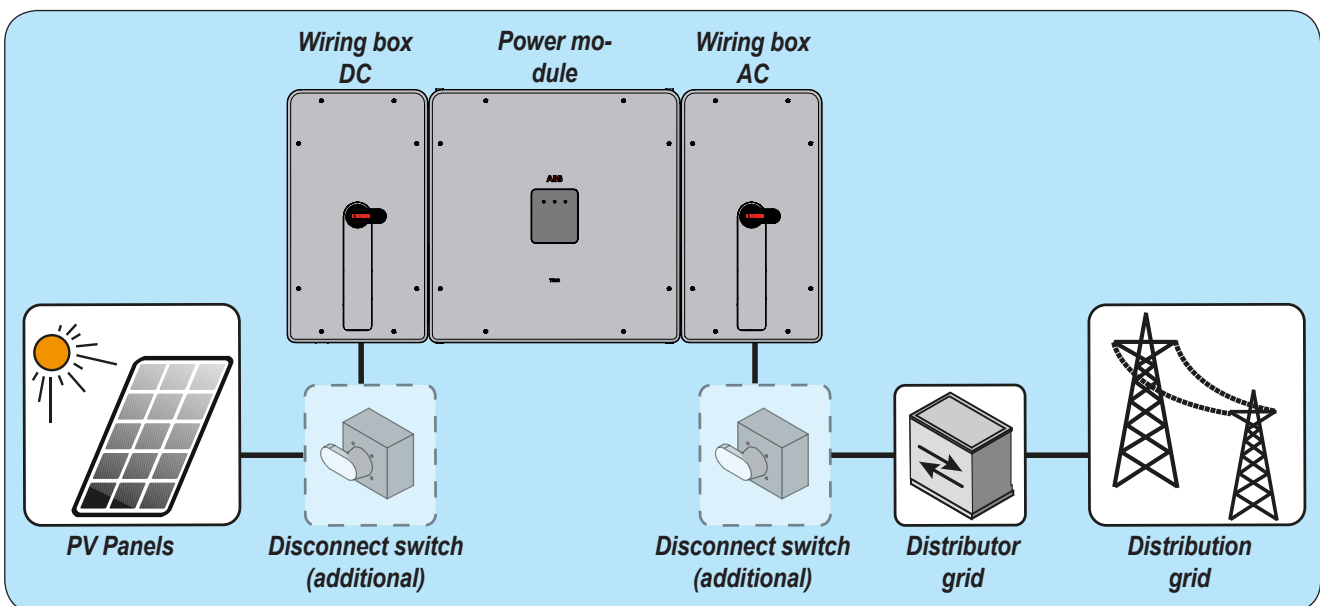

Mutual connection of multiple inverters

If the photovoltaic system exceeds the capacity of a single inverter, it is possible to connect multiple inverters to the system, each of them in turn connected on the DC side to an appropriate section of the photovoltaic generator, and on the AC side to the distribution grid.

Each string inverter will work independently of the others and its own photovoltaic module will supply the maximum power available to the grid.

Notes on the system sizing



Decisions on how to structure a photovoltaic system depend on a series of factors and considerations, such as the type of panels, the space availability, the future location of the system, energy production goals over the long term, etc.

A configuration program that can help to correctly size the photovoltaic system is available on the ABB website (<http://stringsizer.abb.com>).

Functionality and components of the equipment

Configurable relay

The inverter is equipped with a configurable switching relay, which can be used in different operating configurations that can be set using the designated software. A typical example of application is closing the contact when an alarm is triggered.

Remote switch-on/switch-off

This command can be used to switch off/switch on the inverter via an external (remote) command.

This functionality must be enabled in the menu via the designated software and when active, switching on the inverter, besides being dictated by the presence of normal parameters which allow the inverter to be connected to the grid, also depends on the external control for switching on/off.

Reactive power feed into the grid

The inverter is capable of producing reactive power, and then feeding it into the grid through this connection, by setting the phase factor. Managing the input can be controlled directly by the grid company via a dedicated RS485 serial interface or set using the designated configuration software, Aurora Manager LITE.

Power feeding modes vary according to the country of installation and the grid companies. For detailed information on the parameters and characteristics of this function, contact ABB directly.

Limiting the active power fed into the grid

The inverter, if enabled and set using the designated Aurora Manager LITE configuration software, can limit the amount of active power fed into the grid by the inverter to the desired value (expressed as a percentage).

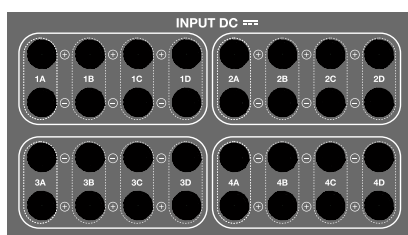

Monitoring string inputs (versions -SX / -SY only)

The inverter, if enabled through the designated Aurora Manager LITE configuration software, can monitor and display the voltage and current of each group of strings input. There are 4 input groups composed by 3 strings (12 inputs version) or 4 strings (16 inputs version).

Overvoltage surge arrester monitoring (only -SX / -SY)

The inverter monitors the status of the overvoltage surge arresters (-SX on AC and DC side) (-SY only on DC side), and generates a warning in the event of a fault (viewable via monitoring system or Aurora Manager LITE software).

Data transmission and control

The inverter or networks of several inverters can be monitored locally or remotely using an advanced communication system based on an RS-485 serial interface that can be configured to communicate using the proprietary "Aurora" or public "ModBus RTU" protocol.

Topographic diagram of the equipment

The diagram summarises the internal structure of the inverter.

The internal circuitry is with double stage conversion and therefore consists of:

- DC/DC input converter (booster)
- DC-AC output inverter

This inverter model works with a single DC-DC converter



The DC-DC converter and the DC-AC inverter both work at a high switching frequency and are therefore small and relatively light.

The input converter is dedicated to an array with a maximum power point tracking (MPPT) function in order to maximize the exportation of energy from the photovoltaic generator.

This inverter version is of the type without transformer, that is without galvanic insulation between the input and the output. This allows ultimately an increase in conversion efficiency. The inverter is already equipped with all the protections necessary for safe operation and compliance with the norms, even without the insulating transformer.

The operation and the protection management of the inverter is controlled by two independent DSPs (Digital Signal Processors) and a central microprocessor.

The connection to the distribution grid is thus kept under control by two independent computers, in full compliance with the electric field norms both for power supply to the systems as well as security.

The operating system carries out the task of communicating with its components in order to carry out data analysis.

In doing all this, we guarantee optimal operation of the whole assembly and a high performance in all irradiation conditions and always ensuring full compliance with the relevant directives, standards and regulations.

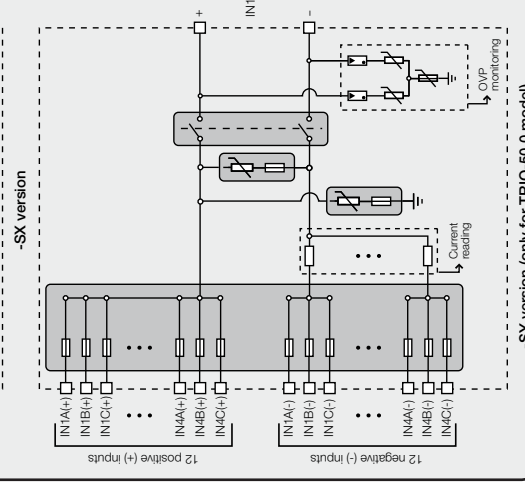
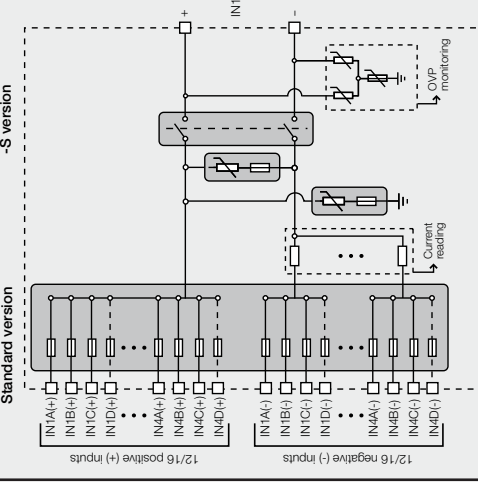
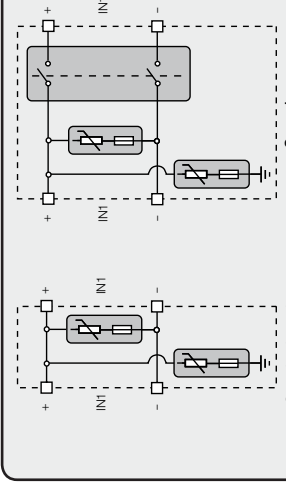
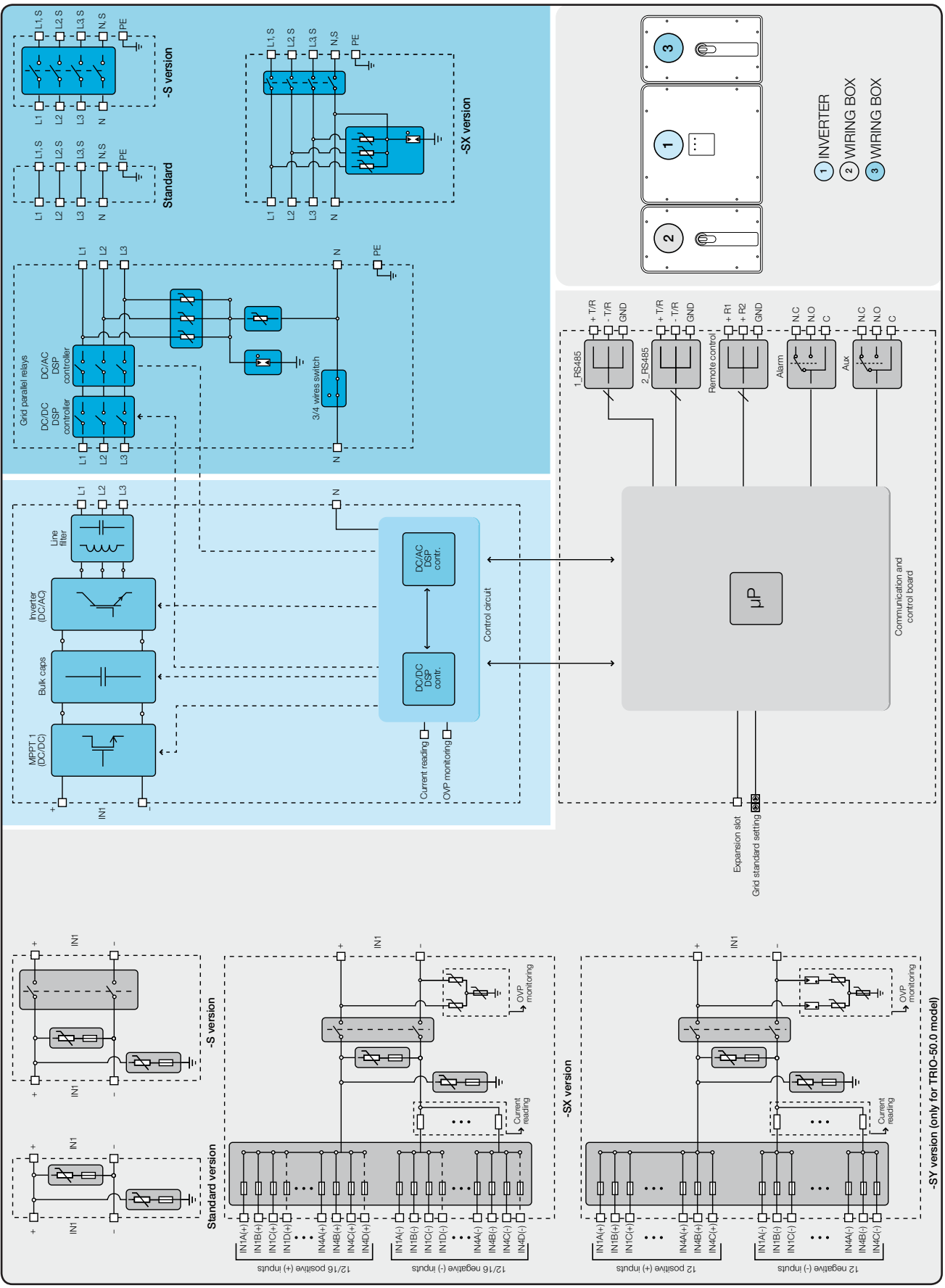

Safety devices

Anti-Islanding

In the event of a local grid outage by the electricity company, or when the equipment is switched off for maintenance operations, the inverter must be physically disconnected to ensure the protection of the people working on the grid, in accordance with the relevant national laws and regulations. To prevent possible islanding, the inverter is equipped with an automatic safety disconnection system called "Anti-Islanding".

The method used to ensure an active anti-islanding protection is: active frequency drift in combination with techniques RoCoF



Anti-islanding protection mechanisms are different depending on the grid standards, even if they all have the same purpose.

Ground fault of the photovoltaic panels

Use this inverter with panels connected in "floating" mode, i.e. with no earth connections on the positive and negative terminals. An advanced ground fault protection circuit continuously monitors the ground connection and disconnects the inverter when a ground fault indicating the fault condition by means of the red "GFI" LED on the LED panel on the front side.

String fuses

In the -SX / -SY versions ② the negative side (-) string fuses ②② and the positive side (+) string fuses ⑩ are preinstalled inside the DC wiring box and protect the appliance from currents exceeding the limit value independently for each string.

The sizing of the fuses must therefore be carefully assessed during installation.

Overvoltage surge arresters

As an additional protection to prevent damage caused by the discharges from lightning and electrostatic induction phenomena, the DC wiring box ② (versions -SX / -SY), is equipped with DC overvoltage surge arresters ⑮ and the AC wiring box ⑤ (version -SX), with AC overvoltage surge arresters ⑱.

Other safeguards

The inverter is equipped with additional protective devices to ensure safe operation in any circumstance. These protections include:

- Constant monitoring of the grid voltage to ensure that voltage and frequency values remain within operating limits;
- Internal temperature control to automatically limit the power if necessary to prevent overheating of the unit (derating).

The numerous control systems determine a redundant structure to ensure absolutely safe operations.



Safety information and instructions

The equipment has been manufactured in accordance with the strictest accident-prevention regulations and supplied with safety devices suitable for the protection of components and operators.



For obvious reasons, it is not possible to anticipate the great number of installations and environments in which the equipment will be installed. It is therefore necessary for the customer to appropriately inform the manufacturer about particular installation conditions.

ABB accepts no liability for failure to comply with the instructions for correct installation and cannot be held responsible for the upstream or downstream equipment.



It is essential to provide operators with correct information. They must therefore read and comply with the technical information provided in the manual and in the attached documentation.



The instructions provided in the manual do not replace the safety devices and technical data for installation and operation labels on the product, and they do not replace the safety regulations in force in the country of installation.

The manufacturer is willing to train staff, at its premises or on site, in accordance with conditions agreed to in the contract.



Do not use the equipment if you find any operating anomalies.

Avoid temporary repairs. All repairs should be carried out using only genuine spare parts, which must be installed in accordance with their intended use.

Liabilities arising from commercial components are delegated to the respective manufacturers.

Hazardous areas and operations

Environmental conditions and risks

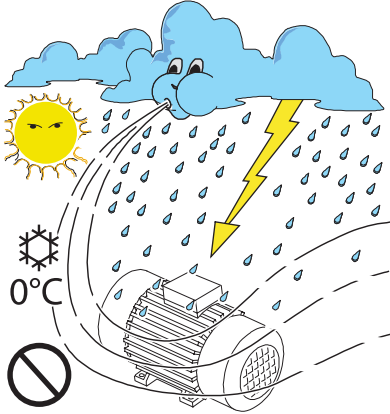

The device can be installed outdoors, but only in environmental conditions that do not prevent its regular operation. These conditions are listed in the technical data and in the installation chapter.

ABB IS NOT responsible for the disposal of the equipment: displays, cables, batteries, accumulators, etc., and therefore the customer must dispose of these items, which are potentially harmful to the environment, in accordance with the regulations in force in the country of installation.

The same precautions should be adopted for dismantling the equipment.



The device is not designed to operate in environments that are particularly inflammable or explosive.

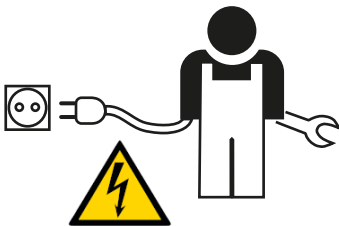

The customer and/or installer must appropriately train operators or anyone who may come into close proximity of the equipment, and highlight, with notices or other means where necessary, the hazardous areas or operations at risk: magnetic fields, hazardous voltages, high temperatures, possible discharges, generic hazard, etc.

Signs and labels



The labels affixed on the equipment must strictly NOT be removed, damaged, defaced, hidden, etc.

The labels must be regularly cleaned and kept in sight, i.e. NOT hidden by foreign objects and parts (rags, boxes, equipment, etc.)

The technical data provided in this manual does not in any case replace that shown on the labels affixed on the equipment.

Thermal and electrical hazard

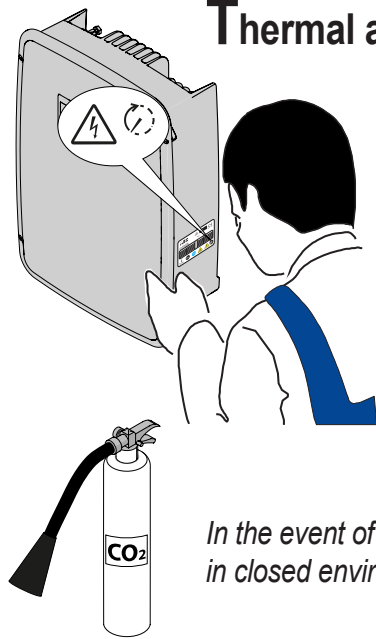

WARNING: the removal of guards or covers is only permitted after the voltage has been removed and time period indicated on the label has passed. This is to let the components cool down and allow the internal capacitors to discharge.

When the device has just been switched off, it may have hot parts as a result of overheating of the heated surfaces (e.g.: transformers, accumulators, coils, etc.) so be careful where you touch.

In the event of fire, use CO2 extinguishers and auto-extraction systems to extinguish the fire in closed environments.



Clothing and protection of personnel

ABB has done its best to eliminate sharp edges and corners, but as this is not always possible you are advised always to wear the clothing and personal protective equipment provided by the employer.



Personnel must not wear clothes or accessories that could start fires or generate electrostatic charges or, in general, clothing that can compromise personal safety.



All operations on the equipment must be performed with adequately insulated clothing and instruments.

E.g.: insulating gloves, class 0, RC category

Maintenance operations may only be performed after the equipment has been disconnected from the grid and from the photovoltaic generator.

Staff must NOT go near the equipment with bare feet or wet hands.

The maintenance technician must in any case ensure that no one else can switch on or operate the device during the maintenance operations, and should report any anomaly or damage due to wear or ageing so that the correct safety conditions can be restored.

The installer or maintenance technician must always pay attention to the work environment, ensuring that it is well-lit and there is enough room to ensure an escape route.



During installation, **consider that the noise emitted based on the environment** could possibly exceed the legal thresholds (less than 80 dBA), therefore, suitable ear protection must be worn.

Residual risks



Despite the warnings and safety systems, there are still some residual risks that cannot be eliminated.

These risks are listed in the following table with some suggestions to prevent them.

Table of residual risks

RISK ANALYSIS AND DESCRIPTION	SUGGESTED REMEDY
 Noise pollution due to installation in unsuitable environments or where staff work permanently.	Reassess the environment or the place of installation.
Suitable local ventilation that does not cause overheating of the equipment and is sufficient not to create discomfort to people in the room.	Restore suitable ambient conditions and air the room.
External weather conditions, such as water seepage, low temperatures, high humidity, etc.	Maintain ambient conditions suitable for the system.
Overheating of surfaces at temperature (transformers, accumulators, coils, etc.) can cause burns. Also be careful not to block the cooling slits or systems of the equipment.	Use suitable protective equipment or wait for the parts to cool down before switching on the equipment.
Inadequate cleaning: compromises cooling and does not allow the safety labels to be read.	Clean the equipment, labels and work environment adequately.
Accumulation of electrostatic energy can generate hazardous discharges.	Ensure the devices have discharged their energy before working on them.
Inadequate training of staff.	Ask for a supplementary course.
During installation, temporarily mounting the equipment or its components may be risky.	Be careful about and disallow access to the installation area.
Accidental disconnections of the quick-fit connectors with the equipment in operation, or wrong connections, may generate electric arcs	Be careful about and disallow access to the installation area.

General conditions

Some recommendation apply only to large size product or multiple small size product packaging.

Transport and handling



Transport of the equipment, especially by road, must be carried out with means for protecting the components (in particular, the electronic components) from violent shocks, humidity, vibration, etc.

During handling, do not make any sudden or fast movements that can create dangerous swinging.

Lifting



ABB usually stores and protects individual components by suitable means to make their transport and subsequent handling easier, but as a rule, it is necessary to utilize the experience of specialized staff in charge of loading and unloading the components.

The ropes and equipment used for lifting must be suitable for bearing the weight of the equipment.

Do not lift several units or parts of the equipment at the same time, unless otherwise indicated.

Unpacking and checking

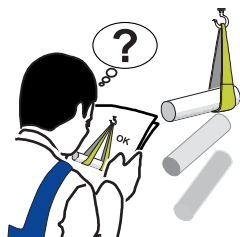
Packaging elements (cardboard, cellophane, staples, adhesive tape, straps, etc.) may cause cuts and/or injuries if not handled with care. They should be removed with the proper equipment.

The components of the packaging must be disposed on in accordance with the regulations in force in the country of installation.

When you open an equipment package, check that the equipment is undamaged and make sure all the components are present. If you find any defects or damage, stop unpacking and consult the carrier, and also promptly inform ABB Service.

Storage

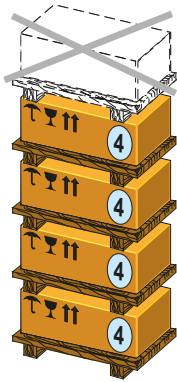

If the package with the power module part is stored correctly, it can withstand a maximum load of 4 stacked devices (divided into 4 pallets).

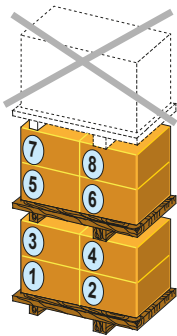

If the package with the wiring box is stored correctly, it can withstand a maximum load of 8 stacked devices (divided into 2 pallets).

DO NOT stack with equipment or products other than those indicated.

Assembly ⁰¹ brackets and/or accessory components are in separate packages and can be piled separately

Weight of the modules of the equipment

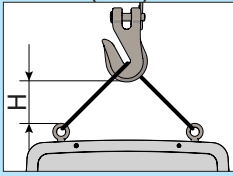
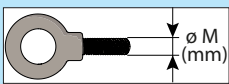
Table: Weights	Weight (kg)	Lifting points (n°#)	Min. height of cables (mm)	Holes or Eyebolts UNI2947
				
Power module	66 kg	4	1.200	M 12 kit of handles ⁰⁶ and eyebolts (to be ordered)
Wiring box DC	Standard / -S: 13 kg -SX / -SY: 14 kg	-	-	-
Wiring box AC	Standard / -S: 14 kg -SX: 15 kg	-	-	-

Types of lifting

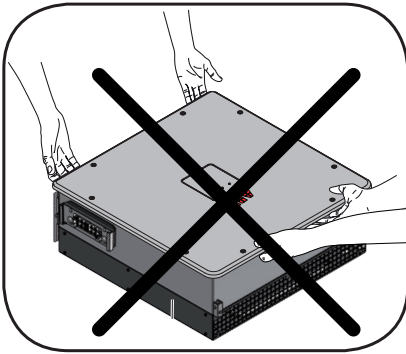

Because of its weight, the power module ③ must be lifted by two people or alternatively using suitable lifting equipment.

it is preferable not to lift the inverter from the cover. If it should be necessary, respect the lifting points at the screws (shown in the figure).

In order to make the power module easier to manage, 4 handles ⑥ can be fitted into the designated holes depending on requirements (4 side holes; 2 top holes; 2 bottom holes).

If lifting with ropes, the eyebolts can be fitted to the holes which are useful for lifting in a vertical position, while if lifting in a horizontal position, it is preferable to use 4 anchoring points at the operator's discretion.





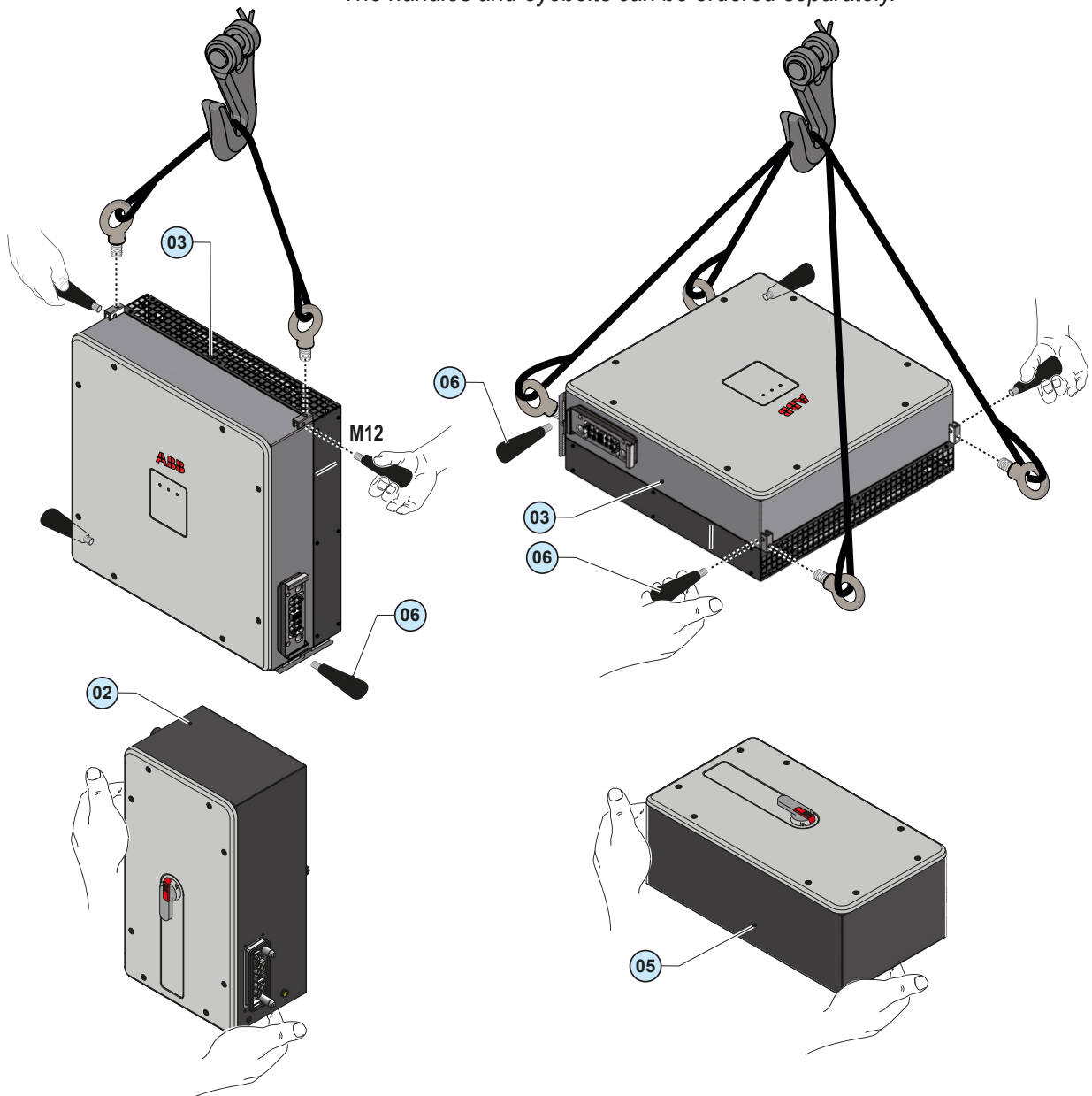

The DC wiring box ② and the AC wiring box ⑤ can be lifted manually as they are of a more limited weight.



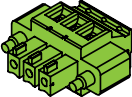
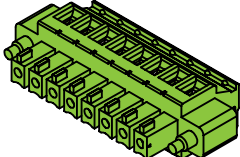
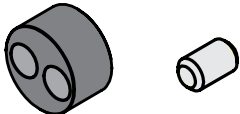

The handles and eyebolts can be ordered separately.

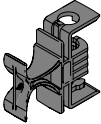

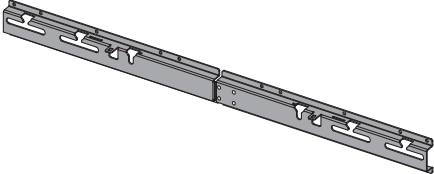
List of components supplied

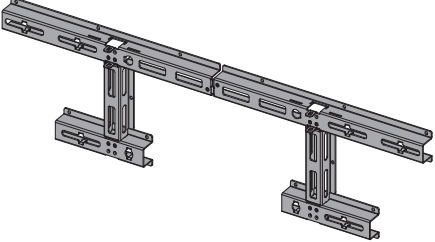
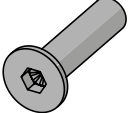
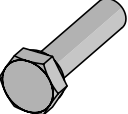
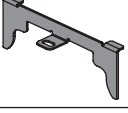
Supplied with the inverter are all the components required to correctly install and connect the inverter

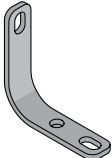
Components available for all DC wiring box models		Qty	
	Connector for connection of the configurable relay	2	
	Connector for connecting the communication and control signals	2	
	Two-hole gasket for signal cable glands ③④ PG 21 + cap	2	
	Two-hole gasket for signal cable glands ③⑤ PG 16 + cap	1	
	M6 nut for securing the ground terminal onto the AC wiring box	1	
	M6 toothed washer for securing the ground terminal onto the AC wiring box	2	
	Technical documentation		
Components available for all DC wiring box models -SX / -SY		Quantity	
	Fuse holder	12 or 16 (depending on the type of wiring box)	
	Negative string fuses (-) ②② (gPV - 1000Vdc - max rating 20A)	12 or 16 (depending on the type of wiring box)	
Components available in the kits supplied with the brackets		Qty (kit vertical installation)	Qty (kit horizontal installation)
	Vertical support assembly ①① bracket.	1	0

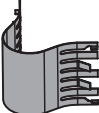
	Horizontal support assembly ① bracket.	0	1
	Countersunk screws M5x14 for mechanically securing the half-brackets	4	10
	Hex head screw M6x16 (4 for securing the ground connection brackets and 2 for the cage nuts)	6	6
	Forks for securing the power module to the wiring boxes	2	2
	Rear spacers for wall alignment (vertical installation)	4	0
	Wiring box/power module ground connection brackets ②	2	2
	Flat washer M6 (4 for securing the ground connection brackets and 2 for the cage nuts)	6	6
	Toothed washer M6 for securing the ground connection brackets	4	4
	Conductor springs	6	6



Kit of recommended spare parts

A list of spare parts that are compatible with the TRIO inverter available (at the ABB warehouse) is given below:

Code	Description	Quantity
TRIO HANDLING KIT	Kit of handles and eyebolts for lifting the power module part	4 handles 2 eyebolts
KIT 10 FUSES 12A	Kit of 12A fuses (gPV - 1000Vdc) (only -SX/-SY)	10
KIT 10 FUSES 15A	Kit of 15A fuses (gPV - 1000Vdc) (only -SX/-SY)	10
KIT SURGE DC SIDE TRIO	Kit of spare cartridges for DC surge arresters type 2 for wiring box -SX	2 (Dehn PN. 952051) 1 (Dehn PN. 952041)
KIT SURGE AC SIDE TRIO	Kit of spare cartridges for AC surge arresters type 2 for wiring box -SX	3 (Dehn PN. 952010) 1 (Dehn PN. 952050)

General conditions

The device is installed depending on the system and the place where the device is installed. Its performance therefore depends on the correctness of the connections.

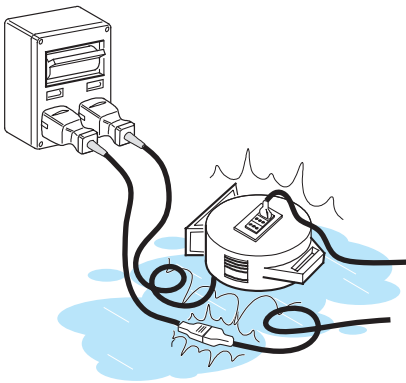

Staff authorised to carry out the installation must be specialised and experienced in this job. They must also have received suitable training on equipment of this type.

The operation must be carried out by qualified personnel and it is advisable to adhere to the indications provided in this manual, the diagrams and the enclosed documentation.



For safety reasons, only a qualified electrician who has received training and/or demonstrated skills and knowledge on the structure and operation of the unit may install the inverter.



The installation must be performed by qualified installers and/or licensed electricians in accordance with the existing regulations in the country of installation.



The removal of the inverter panels/covers allows access to the area dedicated to service personnel (the operator is not authorized to access this area)



Connection of the photovoltaic system to an electric installation connected to the distribution grid must be approved by the electricity provider.



The installation must be carried out with the equipment disconnected from the grid (power disconnect switch open) and with the photovoltaic panels shaded or isolated.



When the photovoltaic panels are exposed to sunlight they provide continuous DC voltage to the inverter.

Installation site and position

- Consult the technical data to check the required environmental conditions (protection rating, temperature, humidity, altitude, etc.)
- Installation of the unit in a location exposed to direct sunlight is acceptable.
- Do not install in small closed rooms where air cannot circulate freely
- Always ensure that the flow of air around the inverter is not blocked so as to prevent overheating.
- Do not install near flammable substances (minimum distance 3 m)
- Do not install near walls in wood or other flammable substances.
- Do not install in rooms where people live or where the prolonged presence of people or animals is expected, because of the high noise that the inverter produces during operation. The level of the sound emission is heavily influenced by where the appliance is installed (for example: the type of surface around the inverter, the general properties of the room, etc.) and the quality of the electricity supply.
- Installation of these models can be carried out vertically or horizontally, with a maximum inclination as indicated in the figure.

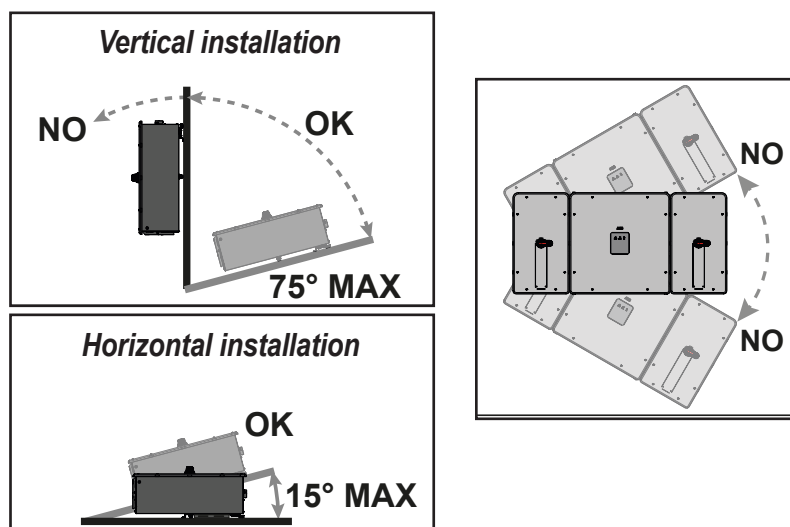

- Hardware and software maintenance on device entails removing the front covers. Check that the correct installation safety distances are observed in order to allow routine check and maintenance operations.
- Install on a wall or strong structure suitable to bear the weight
- If possible, install at eye-level so that the status LEDs can be seen easily.
- Install at a height which takes into consideration the weight of the appliance and in a position which is suitable for servicing, unless suitable means are provided to carry out the operation
- Final installation of the device must not compromise access to any disconnection devices that may be located externally.

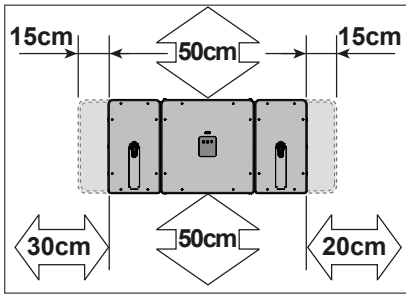

- Respect the minimum distances from objects around the inverter that could prevent the inverter installation and restrict or block the air flow. The wiring boxes are connected to the inverter using quick fit connectors which require sufficient space in order for them to be connected and disconnected easily

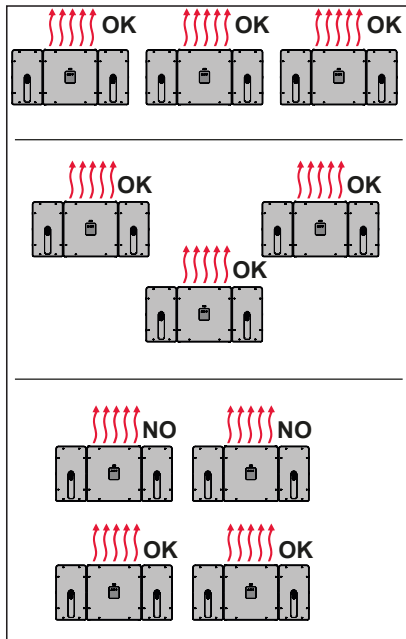

- Provide sufficient working space in front of the inverter that allows to make connections on the wiring box.
- In case of multiple installation position the inverters side by side keeping the minimum distances (measured from the outer edge of the inverter) for each inverter.
- If the space available does not allow this arrangement, position the inverters in a staggered arrangement as shown in the figure so that heat dissipation is not affected by other inverters below.

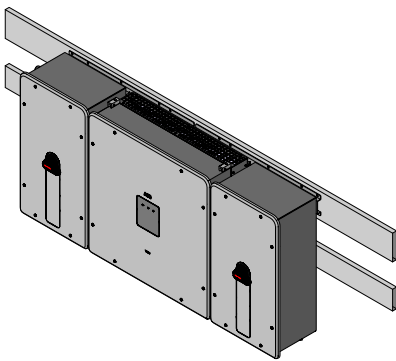

- The vertical installation is also permitted on a structure which must be composed of a support for the attachment of the bracket and one for the support of the rear pins.

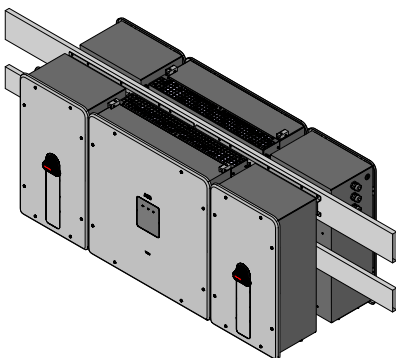

- The vertical installation of two inverters positioned back to back is also permitted on a structure which must be composed of a support for the attachment of the brackets and one for the support of the rear pins.

Please refer to the warranty terms and conditions to evaluate any possible warranty exclusions due to improper installation.

Installations above 2000 metres



On account of the rarefaction of the air (at high altitudes), particular conditions may occur that should be considered when choosing the place of installation:

- Less efficient cooling and therefore a greater likelihood of the device going into derating because of high internal temperatures.
- Reduction in the dielectric resistance of the air which, in the presence of high operating voltages (DC input), can create electric arcs (electrical discharges) that may damage the device.

As the altitude increases, the failure rate of some electronic components increases exponentially because of cosmic radiation.



All installations at altitudes exceeding 2000 metres are prohibited on the basis of the criticalities indicated above.

Installations with a high level of humidity



*Never open the inverter in the case of rain, snow or a level of humidity >95%.
Always carefully seal all unused openings.*

Even though the device is equipped with an anti-condensation valve, air with extremely high levels of humidity can lead to the creation of condensation inside the inverter.

As the inverter is almost completely insulated from the outside, condensation can also form after installation in certain weather conditions.



Mounting with a support bracket

Mounting on a vertical support

- Use 4 of the countersunk M5x14 screws to connect the two bracket pieces together.
- Insert the 2 cage nuts into their seats **B** on the bracket.
- Position the bracket **01** perfectly level on the vertical support and use it as drilling template.

Consider the overall dimensions of the power module along with the 2 wiring boxes.

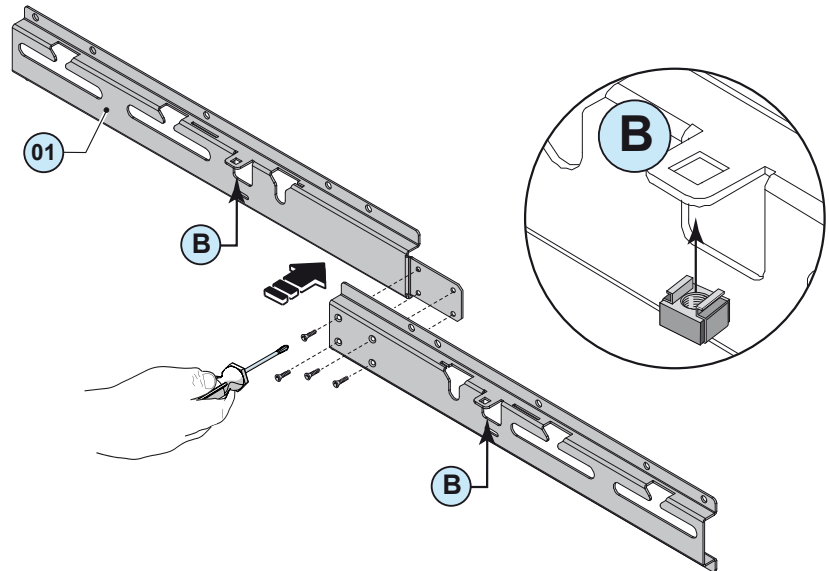

- It is the installer's responsibility to choose an appropriate number and distribution of attachment points. The choice must be based on the type of support (wall, frame or other support), the type of anchors to be used, and their ability to support 4 times the inverter's weight ($4 \times 95\text{Kg} = 380\text{Kg}$ for all models).

Attach the bracket to the wall with at least 10 attachment screws. Depending on the type of anchor chosen, drill the required 10 holes (minimum) **A** to mount the bracket. Put at least four screws in the upper side and at least four in the lower side.

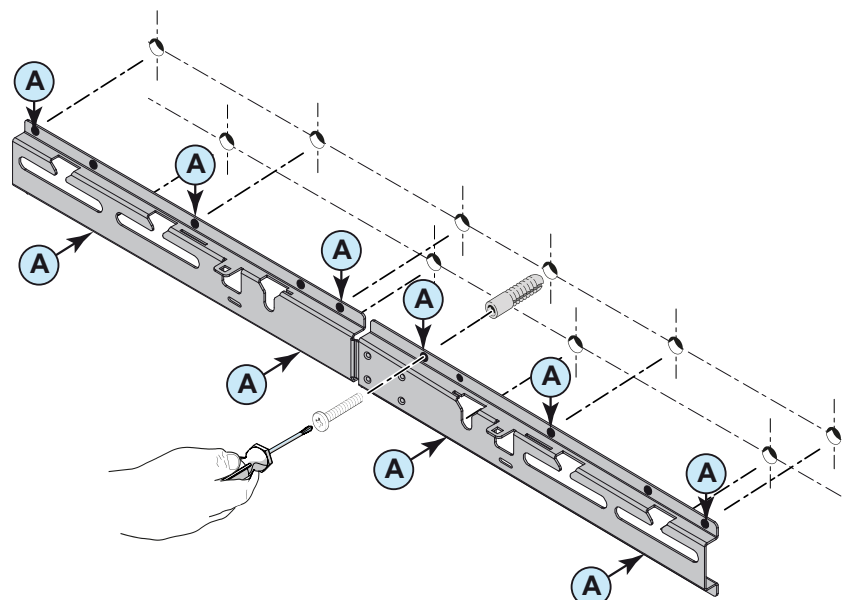

- Fix the bracket to the support.

- Install spacers (24) in the two lower rear attachment pins (27) of the power module. This will prevent backwards tilt when the power module is hung on the bracket.

- Lift the power module up to the bracket using the (optional) handles (06) or the (optional) M12 eyebolts, or another appropriate lifting device. The power module is pre-equipped with metal expansions which allow it to be temporarily put vertically on the floor to make it easier the installation of handles or eyebolts.



Risk of injury due to the heavy weight of the equipment.

- Insert the heads of two upper rear attachment pins (27) into the slots T on the bracket and confirm that the slots L on the bracket are aligned with the line on the sides of the power module. This indicates that they have been correctly positioned.

- Remove handle or eye bolts (if used)

- Remove the quick disconnect connector covers (04) as follows:
 - Pull the metal locking fork (07) outwards (A)
 - Pull off the quick disconnect cover (B)
 Save both parts. They will be needed in a later step.

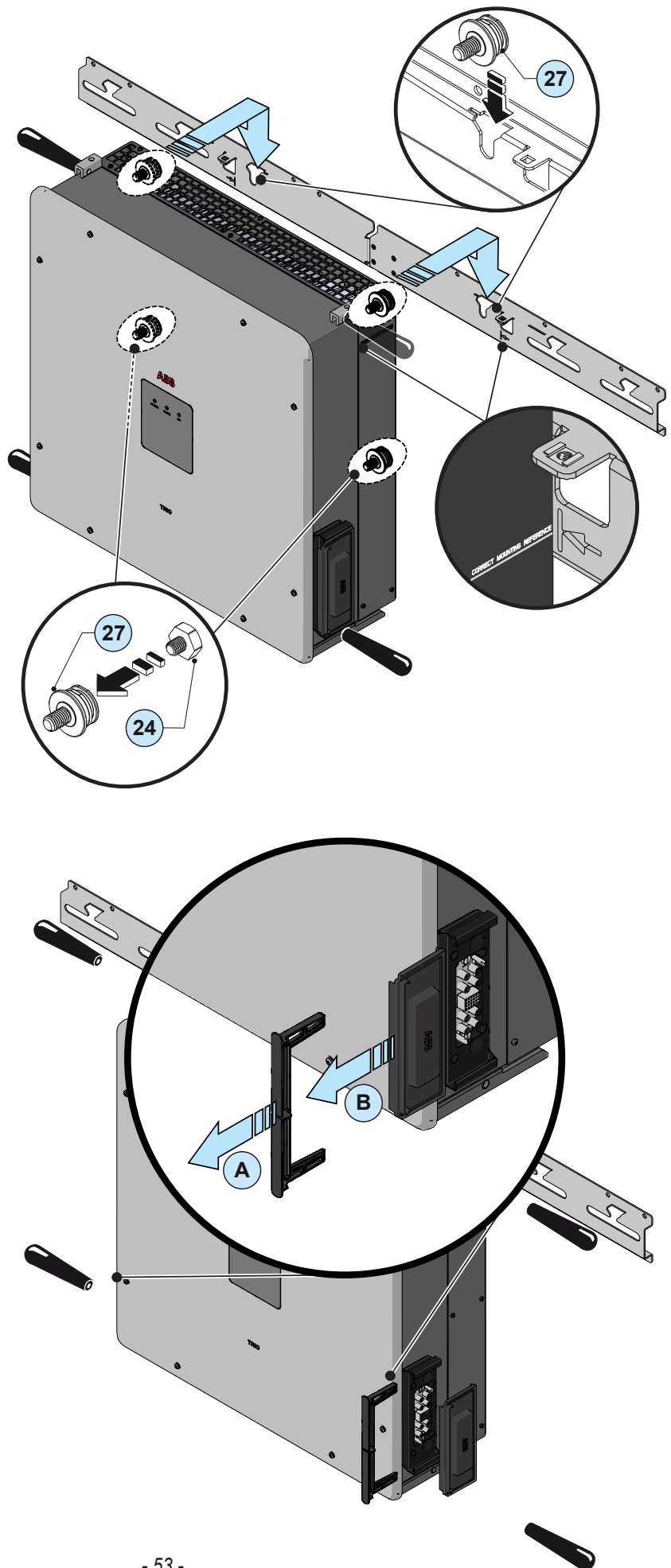

- Set the wiring box disconnect switches to “0”; otherwise it will not be possible to remove the front cover 08.
- Unscrew the 8 screws holding the front covers 08 of the DC wiring box 02 and AC wiring box 05 in place. Don't lose the screws!
- Install 1 spacers 24 in the lower rear attachment pin 27 of each wiring box. This will prevent backwards tilt when the wiring box is hung on the bracket.

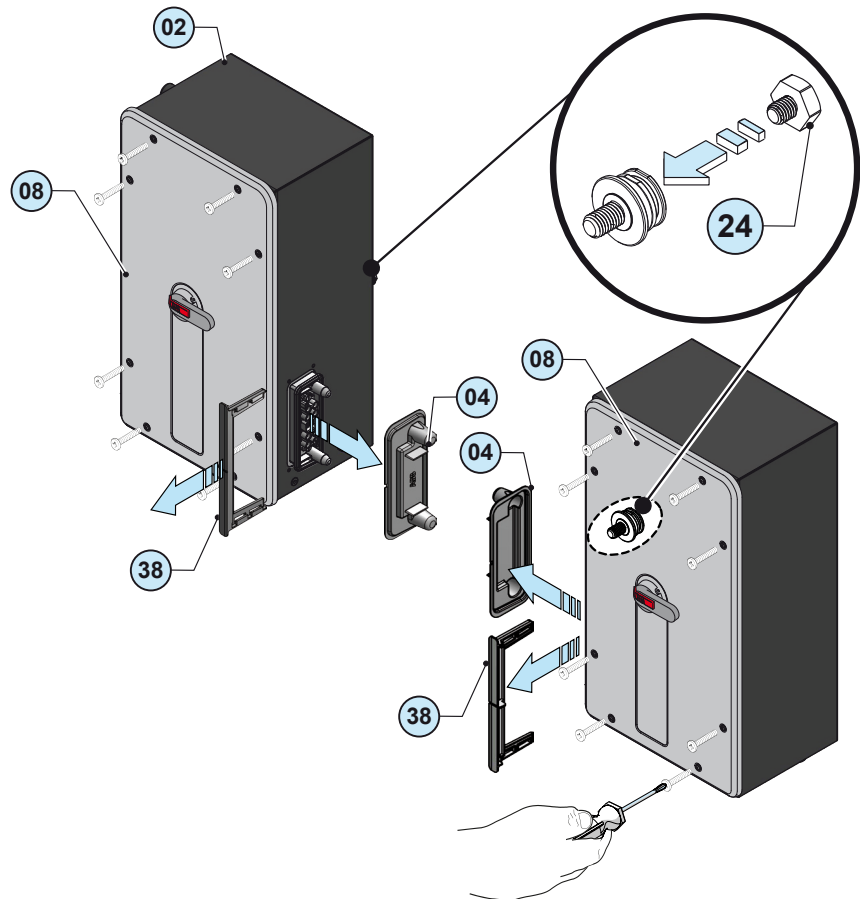

- Remove the covers 04 from the quick disconnect connectors, one on each wiring box.

Then follow these steps to store these caps. They will be needed if the assembly ever needs to be shipped:

- A couple a power module connector cover (green in the figure) with one from a wiring box (in blue in the figure).
- B Slip the plastic locking fork 38, which was used to secure the wiring box cover, over the two covers.
- C Insert the two connector covers and plastic locking fork 41 in the dedicated space in the wiring box D.
- Repeat the same operation for the other wiring box.

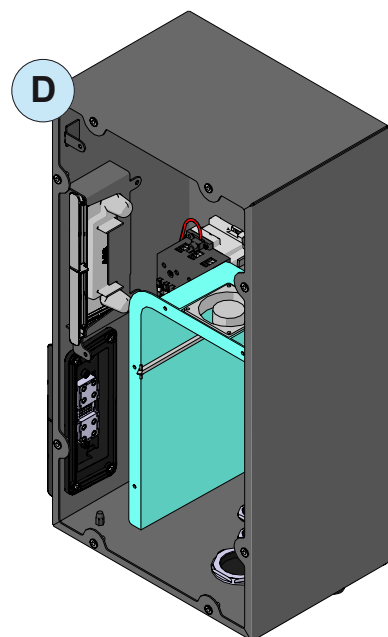
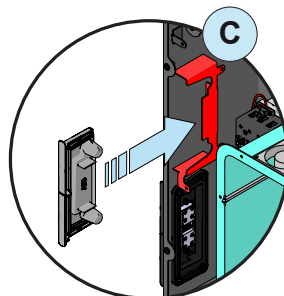
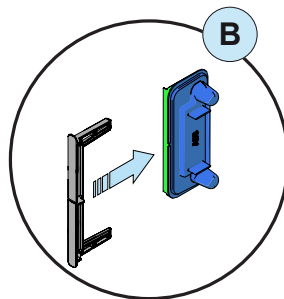
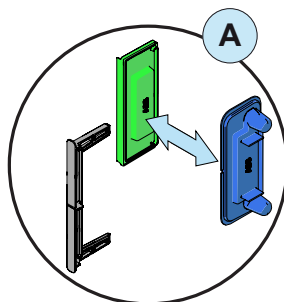

- Install the 2 brackets acting as an earth connection (32) on the provided fastening points (37) (one for each wiring box) and marked with the symbol ⚡. On the figure is shown how to install the brackets on the wiring box.

The bracket is not symmetrical and so it must be fixed on the side with the holes facing down.

Follow the order of installation set out below:

- earth connection bracket
 - flat washer
 - toothed washer
 - fixing screw with hexagonal head.
- During this phase loosely position the screw without tightening it.

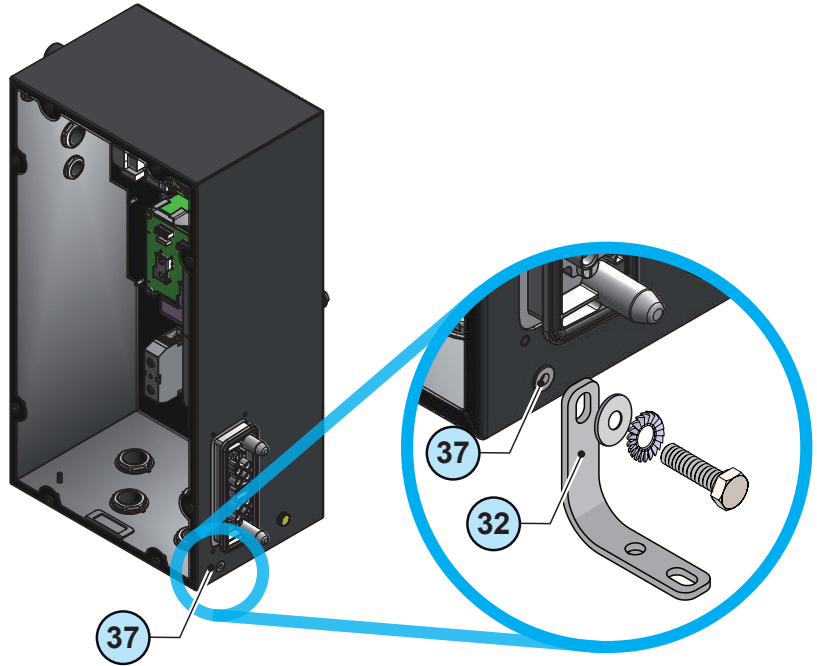

- Insert 1 spacer (24) into the rear pins (27) at the bottom of each wiring box.

- Mount the wiring boxes onto the bracket (01) one at a time inserting the two rear pins (27) at the top into the slots on the bracket.



Risk of injury due to the heavy weight of the equipment.

In this condition, the wiring boxes will be detached from the power module so not to interfere with the quick-fit connectors (23)

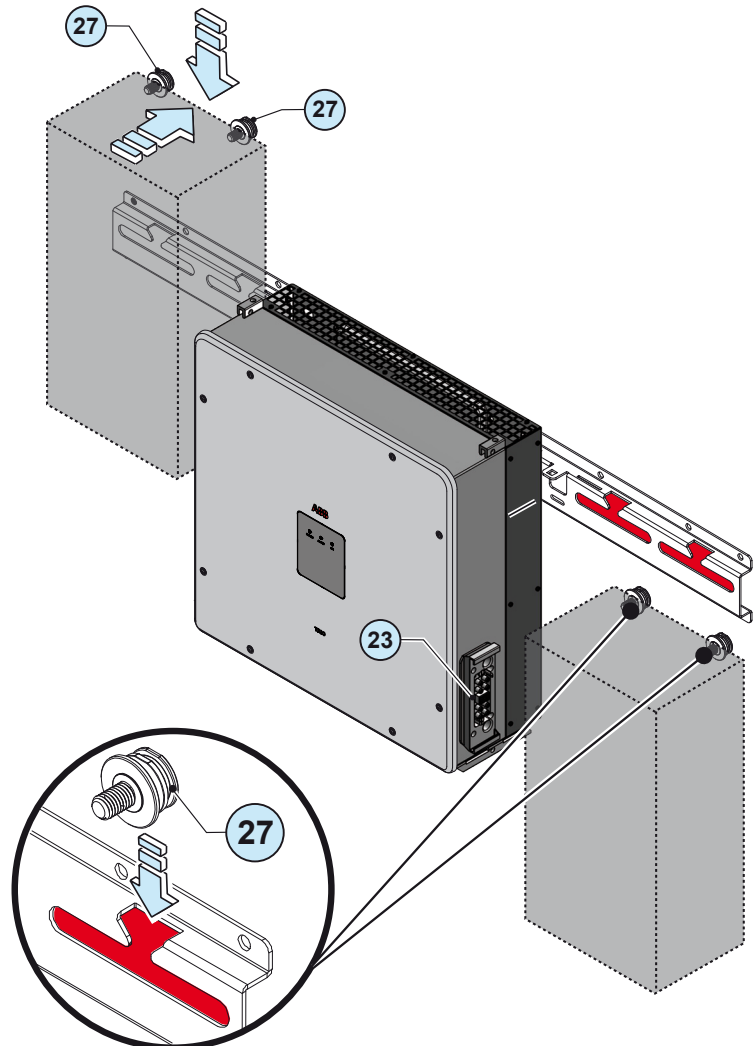

- Couple the wiring boxes to the power module one at a time, making them slide horizontally on the bracket 01 and ensuring that the quick fit connectors are inserted correctly 23.

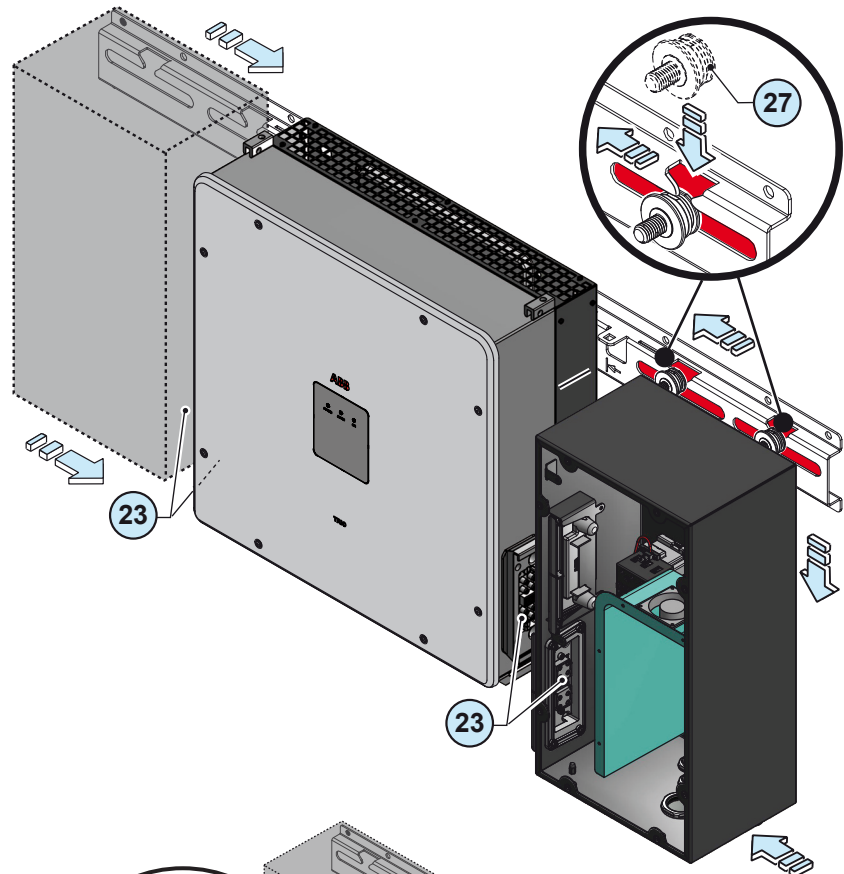

- Once this has been completed, insert the metal locking forks 07 into the designated slots of the quick-fit connectors 23 in order to secure the wiring boxes to the power module.

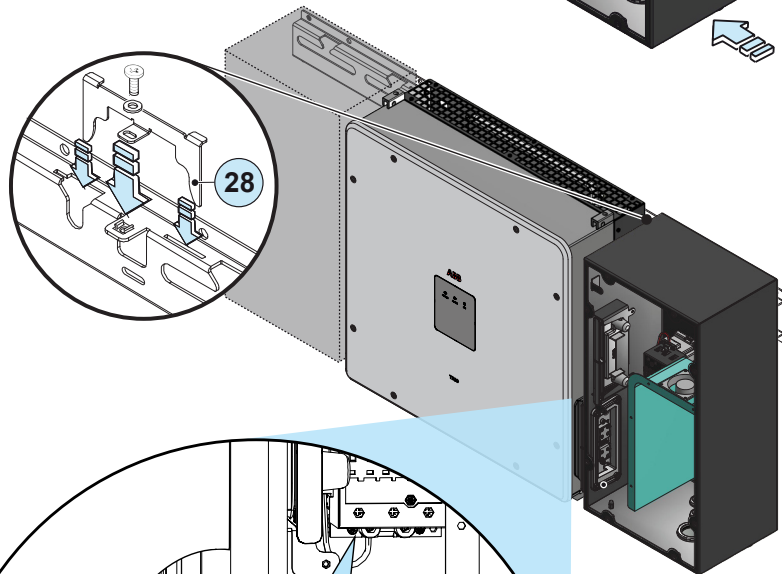

- Install the top stops 28, inserting them into the slots and locking the screws (hex screw M6x16) on the cage nuts which were previously fitted onto the bracket.

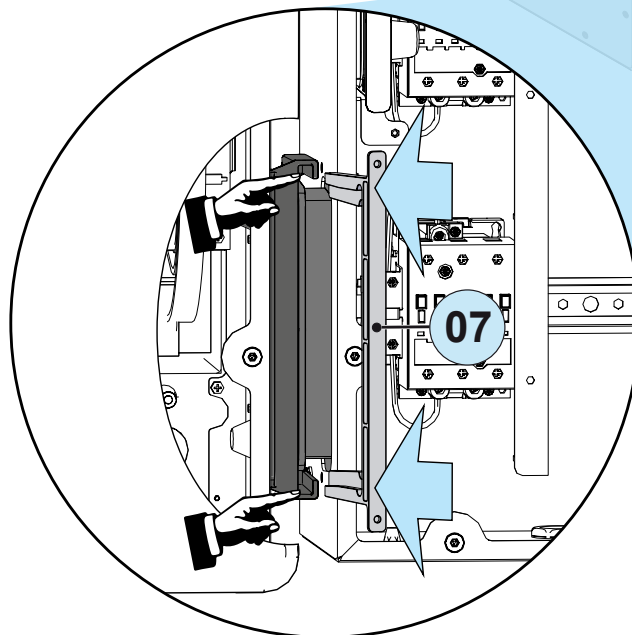



- Before fitting the covers ⑧, install (mandatory) the ground connection brackets ③② into the fastening points ③⑦ at the bottom between the power module and the 2 wiring boxes.

Follow the order of installation set out below:

- earth connection bracket
- flat washer
- toothed washer
- fixing screw with hexagonal head.

Tighten the 2 fixing screws with hexagonal heads on the earth connection points ③⑦ (marked by the symbol ⚡) located on the power module. Then also tighten the 2 fixing screws (one per wiring box) that permanently secure the 2 ground connection brackets ③②.

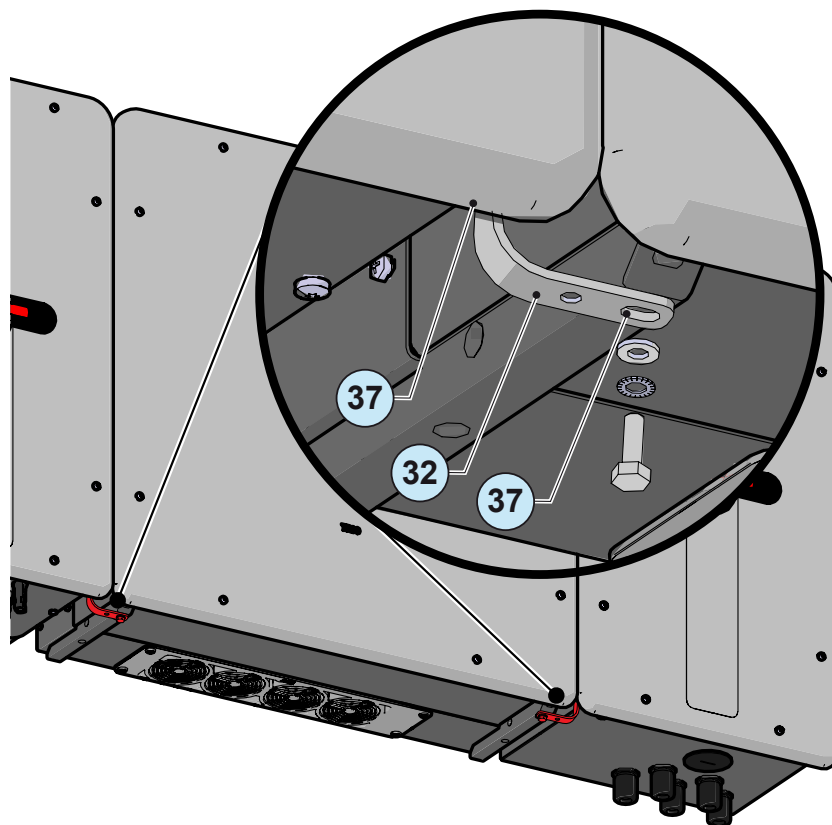

The ground connection between the 3 parts which compose the inverter is ensured by the brackets ③②.

- Proceed with the wiring and connections depending on the model.

Mounting on a horizontal support

- Connect the 6 pieces of the horizontal bracket ① together with the 10 screws (M5x14) shipped with the bracket (refer to figure at right).
- Insert the 2 cage nuts into their seats ② on the bracket.

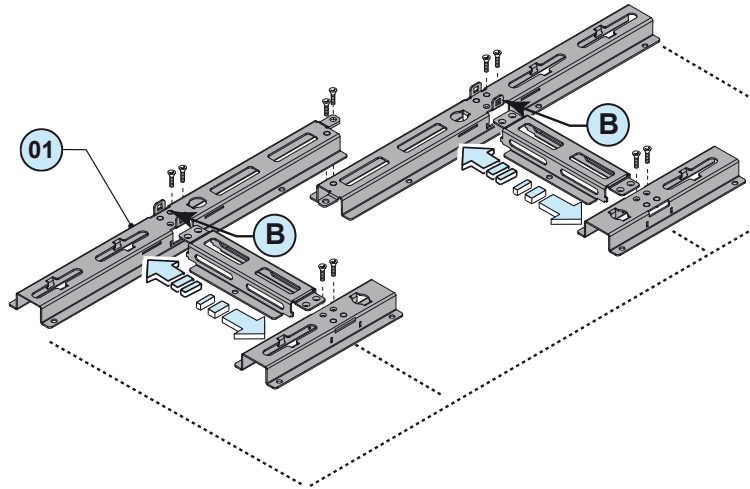

- Position the bracket ① so that it is perfectly flat and use it as a drilling template. Consider the overall dimensions of the power module along with the 2 wiring boxes and check that the bracket is level.

- It is the installer's responsibility to choose an appropriate number and distribution of attachment points. The choice must be based on the type of support and the type of anchors to be used.

Attach the bracket to the support with at least 8 attachment screws. Depending on the type of anchor chosen, drill the required 8 holes ③ to mount the bracket

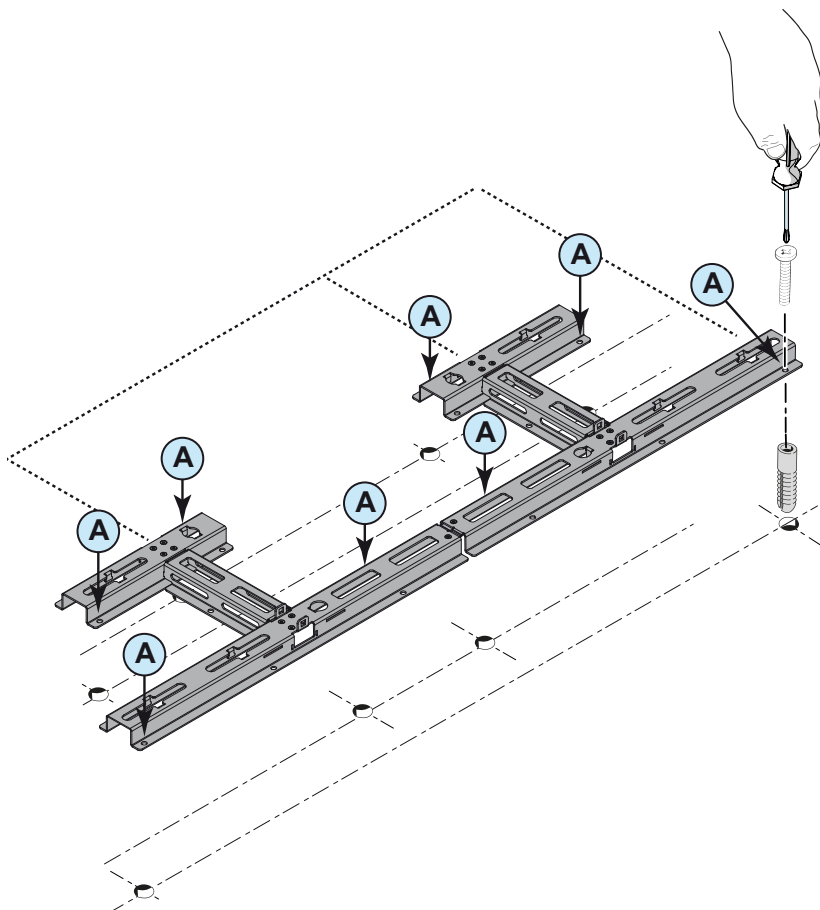

- Fix the bracket to the surface and ensure that it is not distorted in shape.

- Lift the power module up to the bracket using the (optional) handles 06 or the (optional) M12 eyebolts, or another appropriate lifting device. The power module is pre-equipped with metal expansions which allow it to be temporarily put vertically on the floor to make it easier the installation of handles or eyebolts.



Risk of injury due to the heavy weight of the equipment.

- Insert the heads of two upper rear attachment pins 27 into the slots T on the bracket positioning the power module at the center of the bracket.

Check that all 4 rear pins 27 are correctly inserted into the slots.



Risk of injury due to the heavy weight of the equipment.

- Remove handle or eye bolts (if used)
- Remove the quick disconnect connector covers 04 as follows:
 - Pull the metal locking fork 07 outwards A
 - Pull off the quick disconnect cover B
 Save both parts. They will be needed in a later step.

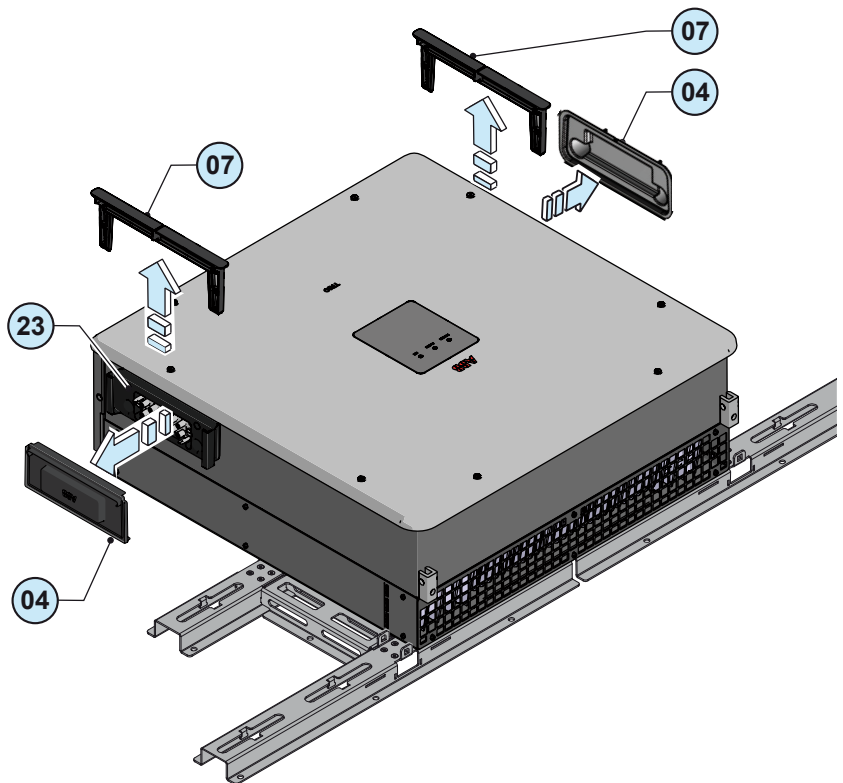
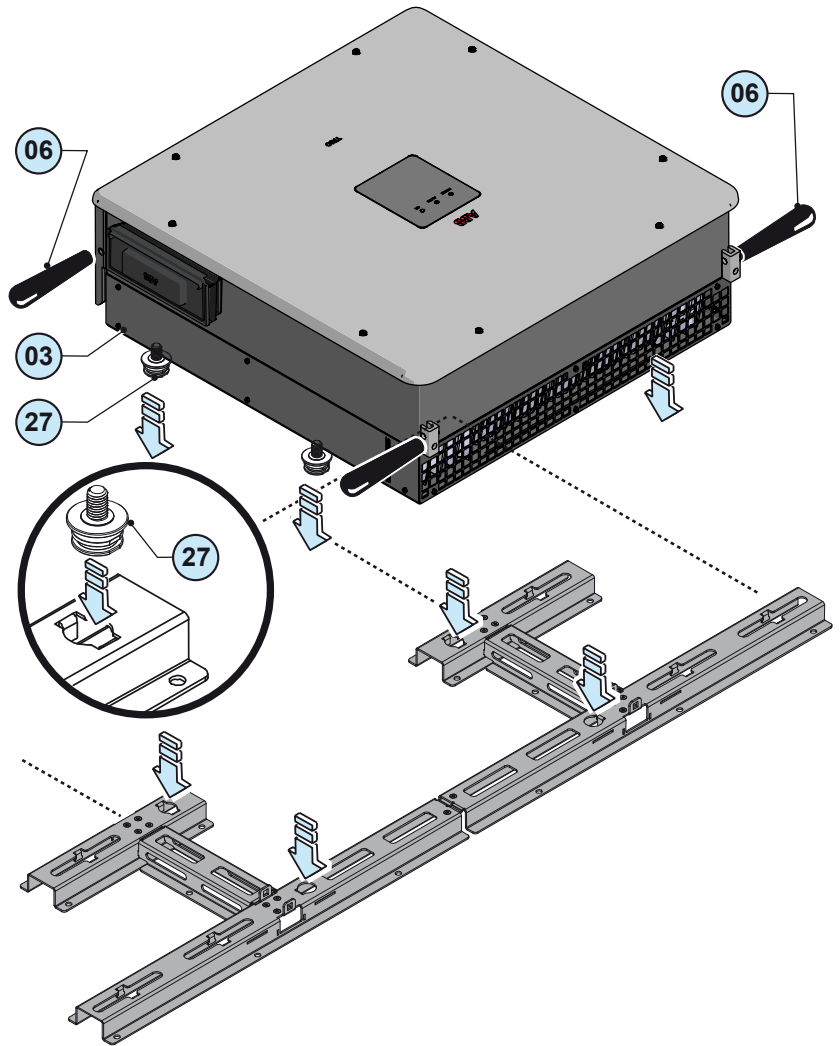

- Set the wiring box disconnect switches to “0”; otherwise it will not be possible to remove the front cover 08.
- Unscrew the 8 screws holding the front covers 08 of the DC wiring box 02 and AC wiring box 05 in place. Don't lose the screws!

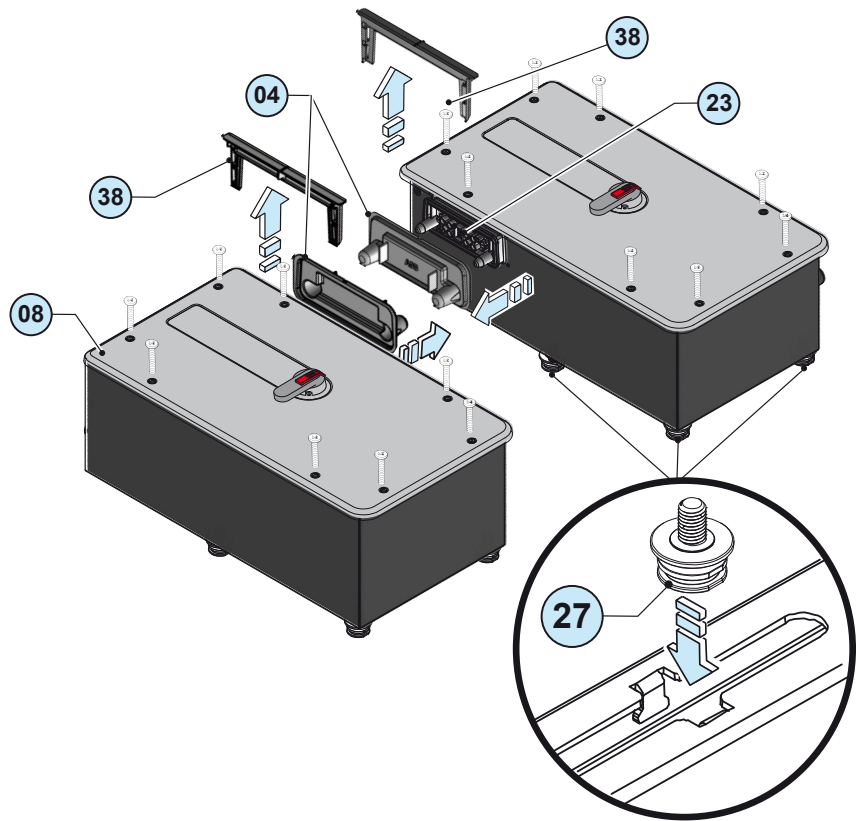

- Remove the covers 04 from the quick disconnect connectors, one on each wiring box.

Then follow these steps to store these caps. They will be needed if the assembly ever needs to be shipped:

- A couple a power module connector cover (green in the figure) with one from a wiring box (in blue in the figure).
- B Slip the plastic locking fork 38, which was used to secure the wiring box cover, over the two covers. **Be sure the fork is plastic, not metal.**
- C Insert the two connector covers and plastic locking fork 41 in the dedicated space in the wiring box D.
- Repeat the same operation for the other wiring box.

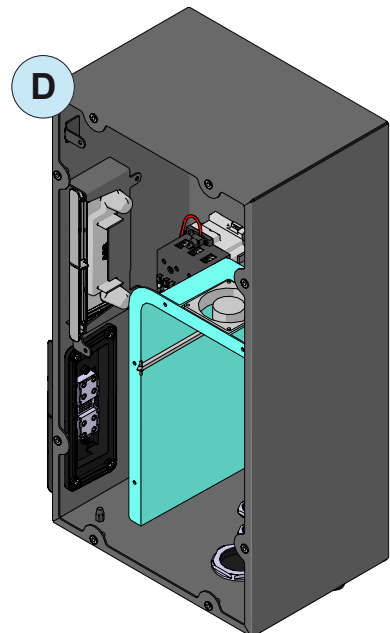
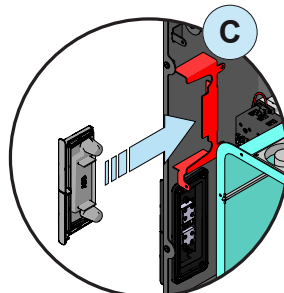
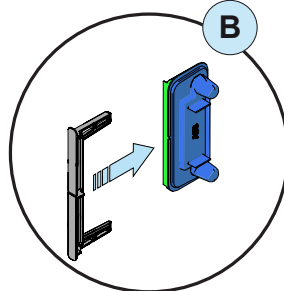
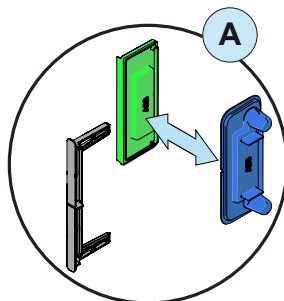

- Install the 2 brackets acting as an earth connection (32) on the provided fastening points (37) (one for each wiring box) and marked with the symbol ⚡. On the figure is shown how to install the brackets on the wiring box. The bracket is not symmetrical and so it must be fixed on the side with the holes facing down. Follow the order of installation set out below:

- earth connection bracket
- flat washer
- toothed washer
- fixing screw with hexagonal head.

During this phase loosely position the screw without tightening it.

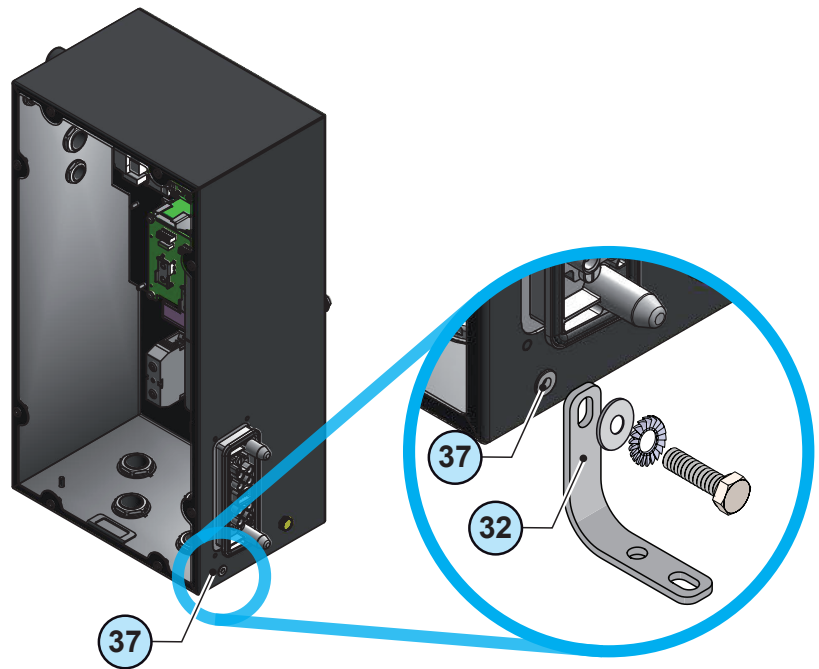

- Mount the wiring boxes onto the bracket (01) one at a time inserting the two rear pins (27) at the top into the slots on the bracket.



Risk of injury due to the heavy weight of the equipment.

In this condition, the wiring boxes will be detached from the power module so not to interfere with the quick-fit connectors (23)

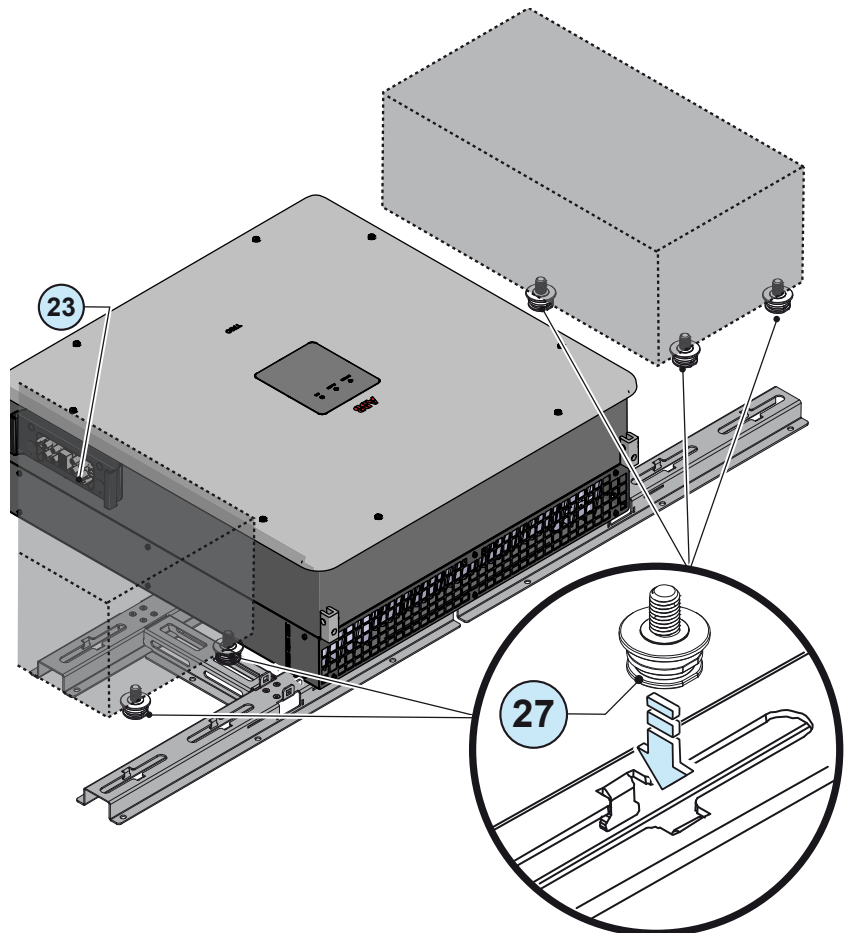

- Couple the wiring boxes to the power module one at a time, making them slide horizontally on the bracket ① and ensuring that the quick fit connectors are inserted correctly ②.

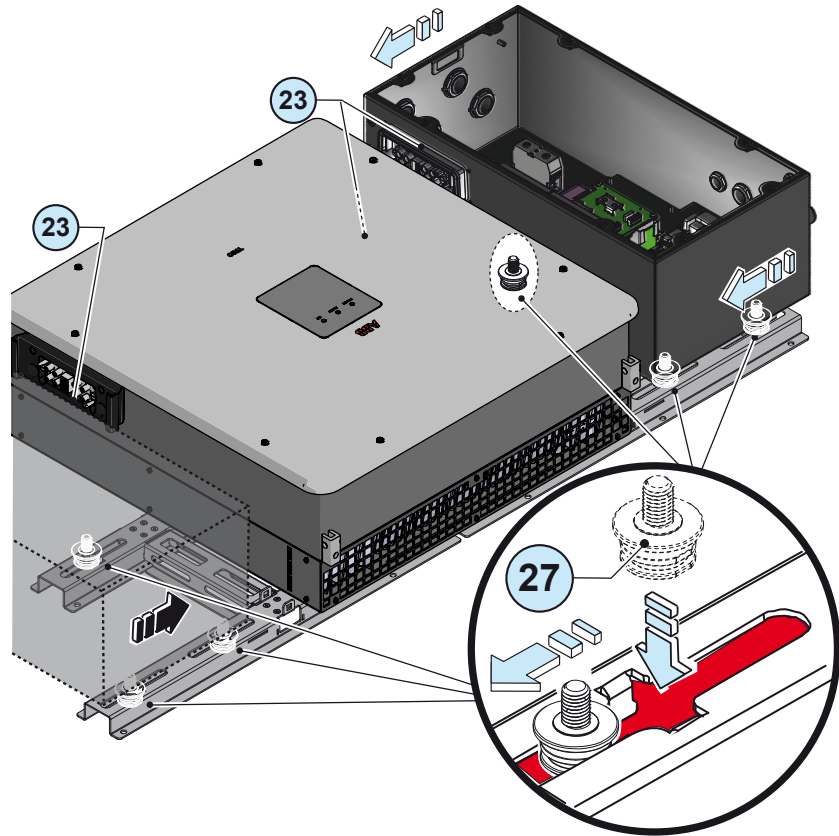

- Once this has been completed, insert the metal locking forks ⑦ into the designated slots of the quick-fit connectors ② in order to secure the wiring boxes to the power module.

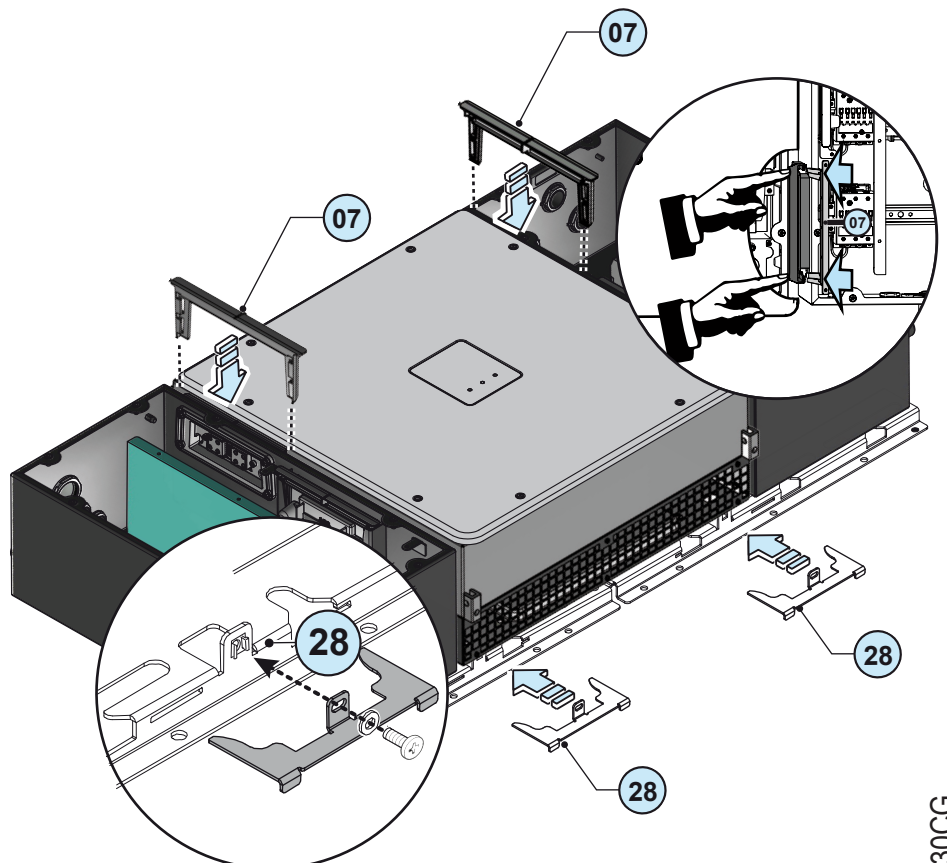

- Install the top stops ⑧, inserting them into the slots and locking the screws (hex screw M6x16) on the cage nuts which were previously fitted onto the bracket.



- Before fitting the covers ⑧, install (mandatory) the ground connection brackets ③② into the fastening points ③⑦ at the bottom between the power module and the 2 wiring boxes.

Follow the order of installation set out below:

- earth connection bracket
- flat washer
- toothed washer
- fixing screw with hexagonal head.

Tighten the 2 fixing screws with hexagonal heads on the earth connection points ③⑦ (marked by the symbol ⚡) located on the power module. Then also tighten the 2 fixing screws (one per wiring box) that permanently secure the 2 ground connection brackets ③②.

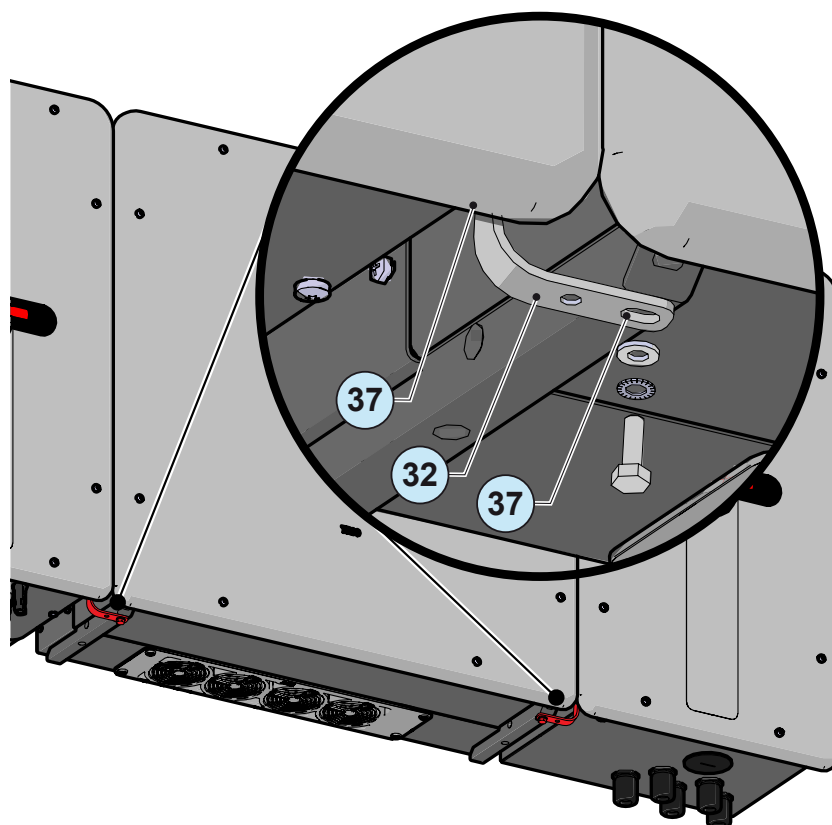

The ground connection between the 3 parts which compose the inverter is ensured by the brackets ③②.

- Proceed with the wiring and connections depending on the model.

Grid output connection (AC side)

The inverter must be connected to a three-phase system with the center of the star connected to ground. To connect the inverter to the grid is possible to choose between the four-wire connection (3 phases + neutral) and the three-wire connection (3 phases).

In any case, the inverter's earth connection is mandatory.

The cable to be used can be five-pole (four-wire configuration), or four-pole (three-wire configuration).

The connections can also be made with the AC wiring box ⁰⁵ detached from the power module ⁰³ which can be connected later for commissioning.

When working with the AC wiring box ⁰⁵ detached, pay particular attention to outdoor installations, where the interface quick connectors ²³ must always be protected by installing the cap ⁰⁴ on the housing.

Characteristics and sizing of the protective grounding cable



ABB inverters must be earthed via the terminal with the protective earth symbol \oplus and using a cable with an appropriate conductor cross-section for the maximum ground fault current that the generating system might experience.



Any failure of the inverter when it is not connected to earth through the appropriate terminal is not covered by the warranty.

In compliance with standard IEC 62109 it is necessary:

- Install a copper grounding cable on the ground protection terminal ²⁰ with a minimum section of 25 mm².
- It is possible to install a second grounding cable (with the same section as the one installed on the ground protection terminal ²⁰) on the connection point located on the underside of the power module and marked with the symbol \oplus .

Installation of a second protective earthing cable is also required by regulations in force in certain countries of installation.



If necessary, carefully read the instructions provided in the paragraph "Installation of the second protective earthing cable".



Before connecting the inverter to a hazardous source of AC or DC voltage, once the earth connections between the inverter modules have been made (and in the same way that the temporary earth connections during the assembly or dismantling stage of the system were made), use a suitable multimeter to test the conductivity of the earth connections between:

- a screw on the cover of the AC wiring box and a screw on the cover of the DC wiring box
- a screw on the cover of the AC wiring box and a screw on the cover of the power module

Characteristics and sizing of the line cable

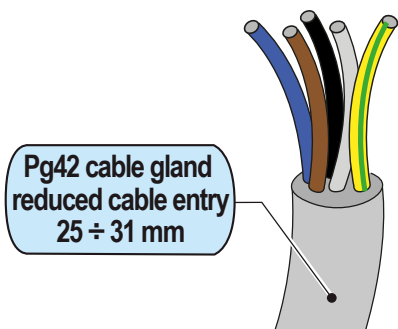

The cross-section of the AC line conductor must be sized in order to prevent unwanted disconnections of the inverter from the grid due to high impedance of the line that connects the inverter to the power supply; If the impedance is too high it causes an increase in the AC voltage which, on reaching the limit set by the standards in the country of installation, causes the inverter to switch off.

The table shows the maximum line conductor length in relation to the section of the conductor itself:

Line conductor cross section (²mm)	Line conductor maximum length (m)	
	TRIO-50.0-TL-OUTD	TRIO-60.0-TL-OUTD-480
25	36 m	43 m
35	52 m	62 m
50	75 m	90 m
70	106 m	127 m
95	144 m	173 m



The values are calculated in nominal power conditions, considering:

- loss of power along the line no greater than 1%
- use of copper cable, with HEPR rubber insulation and positioned in open air.

Load protection switch (AC disconnect switch)

To protect the AC connection line of the inverter, an overcurrent protection device with the following features must be installed:

	TRIO-50.0-TL-OUTD	TRIO-60.0-TL-OUTD-480
Type	Automatic circuit breaker with differential thermal-magnetic protection	
Voltage/current rating	100 A / 400 V	100 A / 480 V
Magnetic protection characteristic	B/C	
Number of poles	3/4	

In case of installation of a residual current protection device must meet the following characteristics:

	TRIO-50.0-TL-OUTD	TRIO-60.0-TL-OUTD-480
Type	A / AC	
Sensibility	500mA	

Connection to terminal block AC side



To avoid risks of electrical shock, all wiring operations must be carried out with the disconnect switch downstream of the inverter (grid side) off.

Be careful not to change round one of the phases with neutral!



Grounding is essential before connection to the power supply network.

Standard (AC)

For the AC wiring box Standard model

Connection of AC cable (25 to 31mm diameter, copper or aluminum) is made to the AC output terminal block (17); the terminal block accepts cables with a maximum-cross section of 95 mm² (torque to 20Nm).

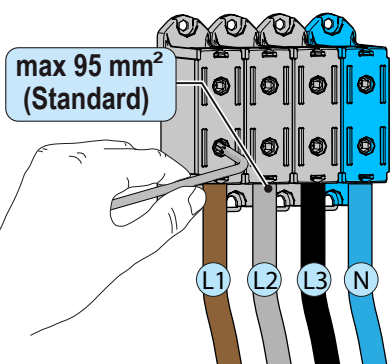

To carry out the connections, a multicore cable can be passed through the single AC cable gland (16) or separate cables through the individual AC cable glands (30).

The default configuration is with a single AC cable gland (16). If it is necessary to use the five individual AC cable glands (30) must be used the M32 measure.

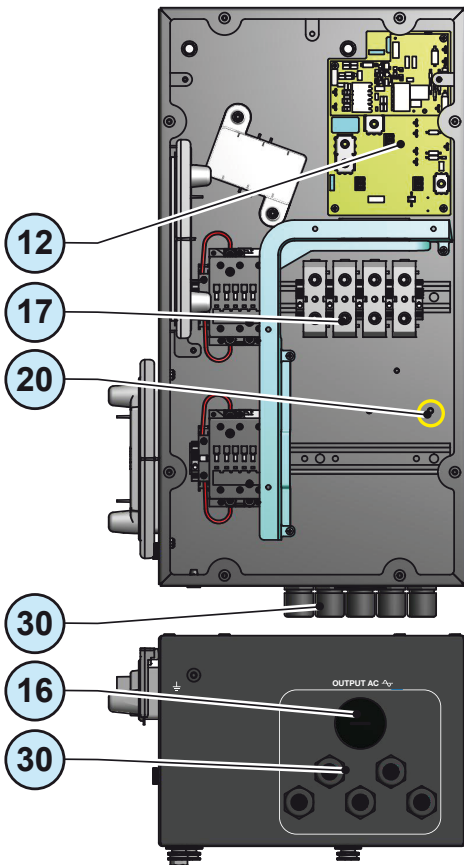

For the AC wiring boxes model -S and -SX

Connection of AC cable (25 to 31mm diameter, copper) is made to the AC disconnect switch (36); the AC disconnect switch accepts cables with a maximum-cross section of 70 mm² (torque to 6Nm). Aluminum cables can be installed using special bi-metal terminals.

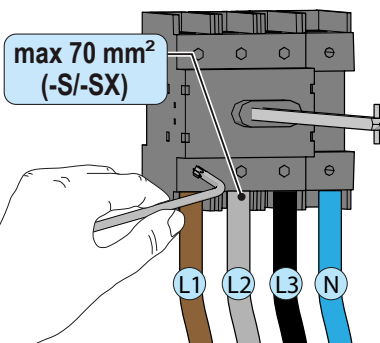

To carry out the connections, a multicore cable can be passed through the single AC cable gland (16) or separate cables through the individual AC cable glands (30). The default configuration is with a single AC cable gland (16). If it is necessary to use the five individual AC cable glands (30) must be used the M32 measure.

-S / -SX (AC)

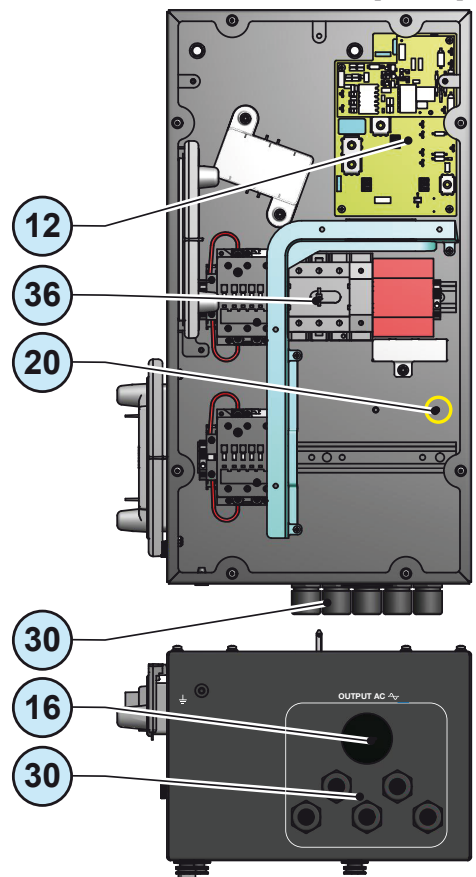

AC cable installation:

- Unscrew the cable gland or the cable clamps and remove the cover
- Introduce the cable with a suitable cross-section
- Connect the earth cable to the designated threaded metal insert or earth protection terminal (20) following to the sequence illustrated in the figure. A ring cable lug, suitable for a M6 size threaded insert, must be fixed t
- Connect the Neutral, R, S, T wires to the respective terminals:
 - On the AC output terminal block (17) for the Standard wiring box
 - Directly to the AC disconnect switch (36) for the -S and -SX wiring box.
 Observe the connection sequence of the phases R, S, T indicated on the label placed near the AC terminals.

In case of using aluminum cables for AC connections, consider that:

- The terminal present on the Standard version accepts the connection of copper and aluminum cables.
- For -S and -SX versions must be used bimetallic terminals suitable to coupling the aluminum wires with the internal contacts of the AC disconnect switch.

- Give each wire a pull test to confirm the connection is secure
- Set the switch **b01** based on the configuration of the output connections.

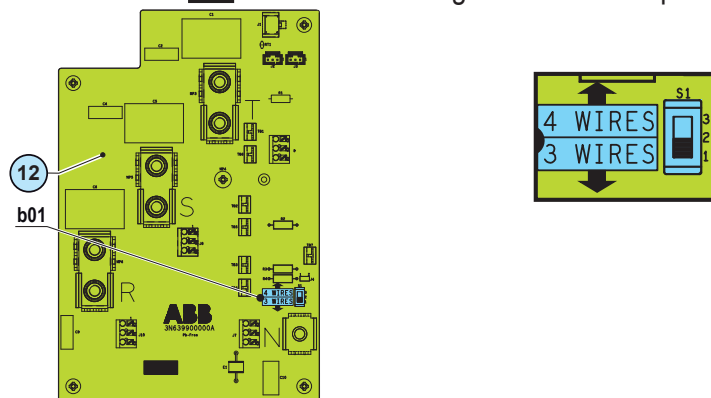

- **3WIRES** position. Three wires configuration (R+S+T)
- **4WIRES** position. Four wires configuration (R+S+T+Neutral)

- Before connecting the inverter to the distribution grid it is necessary to set the country standard by turning the two rotary switches **a05** and following the table provided in the “Preliminary operations before commissioning” paragraph.

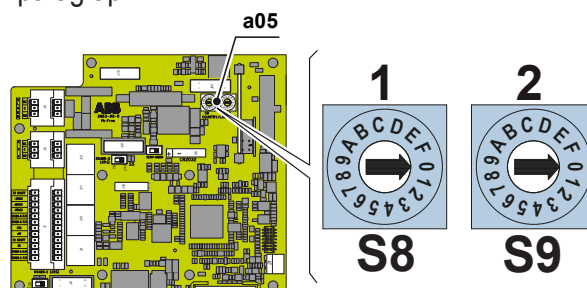

Installation of the second protective earthing cable

The insertion of a second earth cable may be required by the regulations of the country of installation. In making the connection, the following conditions must be fulfilled:

1. the ground cable must be secured to one of the dedicated connection points and identified by the symbol \oplus

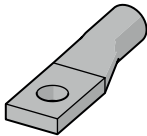

2. use a cable lug (not supplied) of a suitable size for installation on one of the M6 screws (supplied) used for securing the ground connection brackets $\textcircled{32}$

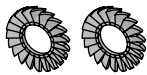

3. the cable lug must be installed between the two toothed washers M6 (not supplied)

4. Secure the cable lug using the screw and the two washers tightening to a torque of 11 Nm.

The connection point can be positioned below the ground connection brackets $\textcircled{32}$ or between the bracket $\textcircled{32}$ and the fastening points $\textcircled{37}$.

The figure below shows an installation example of the protective grounding cable:

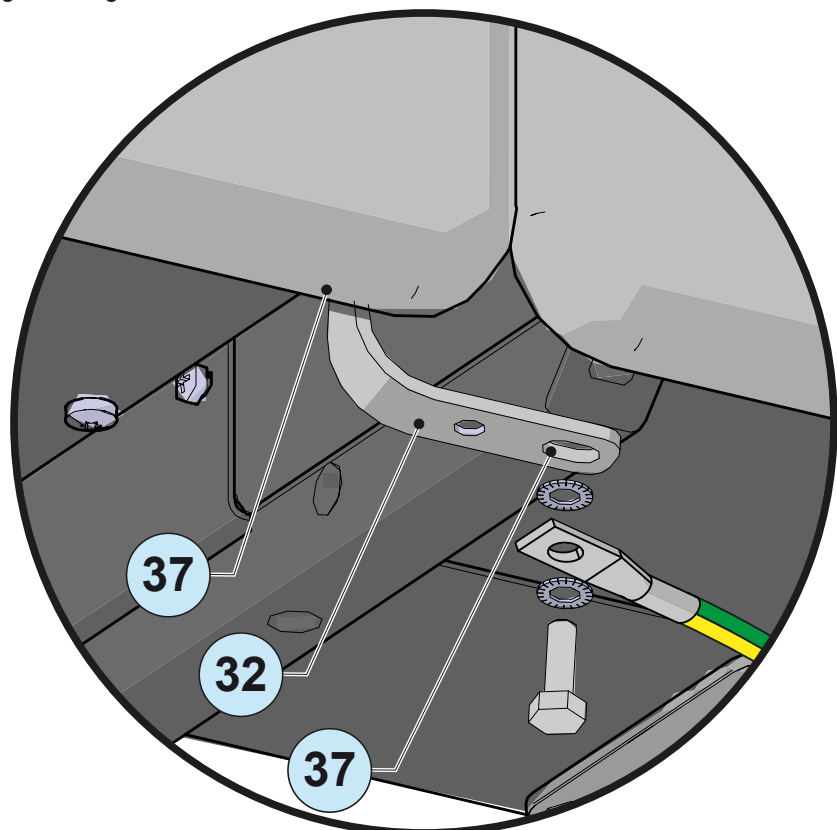

Operations preliminary to the connection of the PV generator

In order to perform safely the preliminary operations before the connection to the PV generator it is needed that the DC wiring box is connected to the ground. Preliminary operations can be performed in two different circumstances:

1. Inverter installed (power module and both the wiring boxes). In this case check that the grounding connection in the wiring box is present and that both the ground connection brackets (32) have been installed correctly
2. DC wiring box disconnected from the inverter. In this case it is necessary a temporary grounding connection to be removed after the complete installation of the inverter (power module and both the wiring boxes) and after the connection of the grounding cable in the AC wiring box and the installation of ground connection brackets (32).

The temporary ground connection is made on additional hole on the grounding bracket (32).

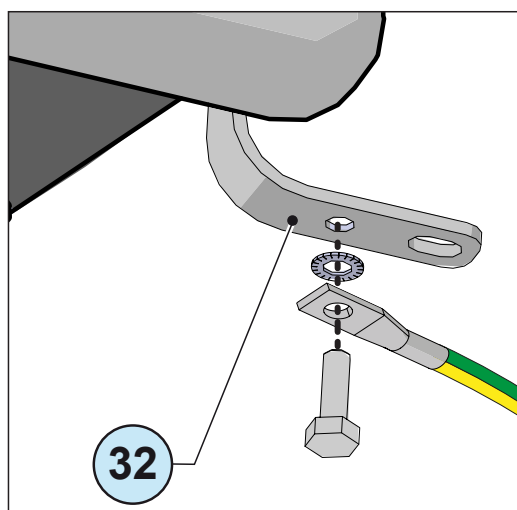

Use the M6 screw and washer (not supplied) to fix the temporary earth cable

Checking of leakage to ground of the photovoltaic generator

Measure the voltage present between positive and negative pole of each string with respect to ground.

If a voltage is measured between an input pole and ground, it may be that there is a low insulation resistance of the photovoltaic generator and the installer will have to carry out a check to solve the problem.



Do not connect the strings if a leakage to ground has been detected, as the inverter might not connect to the grid.

Checking of strings voltage

Measure the voltage present between positive and negative pole of each string.

If the open circuit voltage of the string is near the maximum value accepted by the inverter, consider that low ambient temperatures cause an increase in the string voltage (different according to the photovoltaic module used). In this case it is necessary to carry out a check of the sizing of the system and/or a check on the connections of the modules of the system (e.g.: number of modules in series higher than the design number).

Input voltages higher than the maximum value accepted by the inverter (see technical data table) may occur the damage of the inverter.

Checking the correct polarity of the strings (standard / -S versions)

Before wiring the strings for the **Standard and -S** versions, you must ensure that the voltage of each string complies with the correct polarity using a voltmeter.

Selection of differential protection downstream of the inverter

All ABB string inverters marketed in Europe are equipped with a device for protection against ground faults in accordance with the safety standard IEC 62109-2, please refer to sections 4.8.2 and 4.8.3 of the Standard (equivalent to Standard DIN V VDE V 0126-1:2006, section 4.7). In particular, ABB inverters are equipped with a redundancy on the reading of the ground leakage current sensitive to all components of both direct and alternating current. Measurement of the ground leakage current is carried out at the same time and independently by 2 different processors: it is sufficient for one of the two to detect an anomaly to trip the protection, with consequent disconnection from the grid and stopping of the conversion process.

There is an absolute threshold of **500 mA** of total leakage current AC+DC with protection tripping time at a max. of 300 msec.

Furthermore, there are another three tripping levels with thresholds respectively at **30 mA, 60 mA and 150 mA** to cover the “rapid” changes in fault current induced by accidental contact with leaking live parts. The max. tripping times are progressively shortened as the speed of change in the fault current increases and, starting from the 300 msec/max for the 30 mA change, they are shortened respectively to 150 msec and 40 msec for 60 mA and 150 mA changes.

It should in any case be noted that the integrated device only protects the system against ground faults that occur upstream of the AC terminals of the inverter (namely towards the DC side of the photovoltaic system and consequently towards the photovoltaic modules). The leakage currents that can occur in the AC section between the draw/feed in point and the inverter are not detected and require an external protection device.

For protection of the AC line, on the basis of the information above with regard to the differential protection integrated in **ABB** inverters, **it is not necessary to install a type B ground fault switch.**

In accordance with article 712.413.1.1.1.2 of Section 712 of IEC Standard 64-8/7, we hereby declare that, because of their construction, ABB inverters do not inject ground fault direct currents.



The use of an AC type circuit breaker with differential thermal magnetic protection with tripping current of 500 mA is advisable so as to prevent false tripping, due to the normal capacitive leakage current of photovoltaic modules.



In the case of systems which consist of several inverters connected to a single switch with differential protection it is recommended that a device is installed which allows the adjustment of the tripping value and the tripping time.



Configuration of the input channels

All versions of the inverter are fitted with an input channel (i.e. a single maximum power point tracking MPPT).

Strings of photovoltaic modules having the same type and number of panels in series must be connected to the input channel; they must also have the same installation conditions (in terms of orientation to the SOUTH and inclination from the horizontal plane).



All input parameters that must be met for correct inverter operation are shown in the "technical data" table.

Input connection to PV generator (DC side)



After having carried out preliminary checks and therefore having verified that there are no problems in the photovoltaic system, the inputs can be connected to the inverter.

The connections can also be made with the wiring box 02 ⁰² detached from the power module ⁰³ that can be connected later for commissioning.

When working with the wiring box ⁰² detached, pay particular attention to:

- presence of temporary ground connection
- coupling connector must always be protected in outdoor installations.

The DC side connections are different according to the wiring box used:

- the **Standard / -S** models use cable glands
- the **-SX / -SY** models use quick fit connectors (one for each pole of each string).

*On the **Standard / -S** versions, the connection in parallel of the strings (array composition) must take place upstream of the input in the inverter and must be made by technicians during installation.*

The **-SX / -SY** versions accept a direct single strings connection with connectors which are located on the outside of the wiring box ⁰².



To prevent electrocution hazards, all the connect operations must be carried out with the DC disconnect switch ¹⁴ and the AC disconnect switch ³⁶ open.

Connection of inputs on the Standard and -S models

For these two models connection with the DC input terminal board ¹³ is made by inserting the cables into the cable glands ¹¹.

The maximum cable diameter accommodated by the cable gland is between 13 to 21 mm, while each terminal clamp on the terminal block accepts a cable with a maximum cross-section of 95 mm² (copper or aluminum).

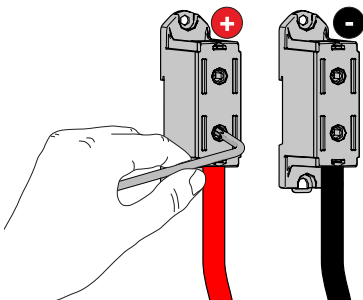
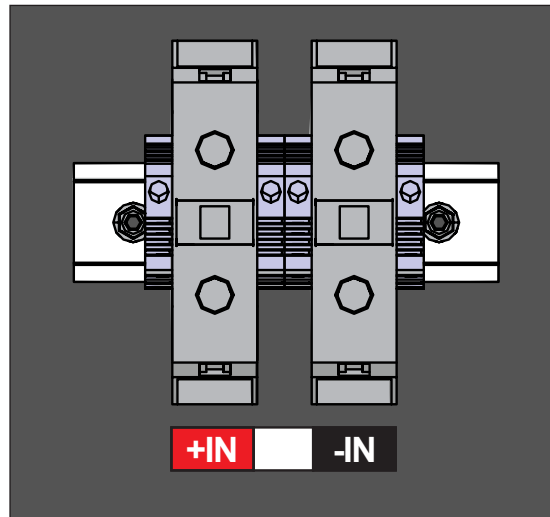

Unscrew the cable gland, remove the cover, feed a cable of suitable cross-section and connect it to the terminals on the DC input terminal block. ¹³.

Once connection to the terminal block has been completed, retighten the cable gland firmly and check seal.

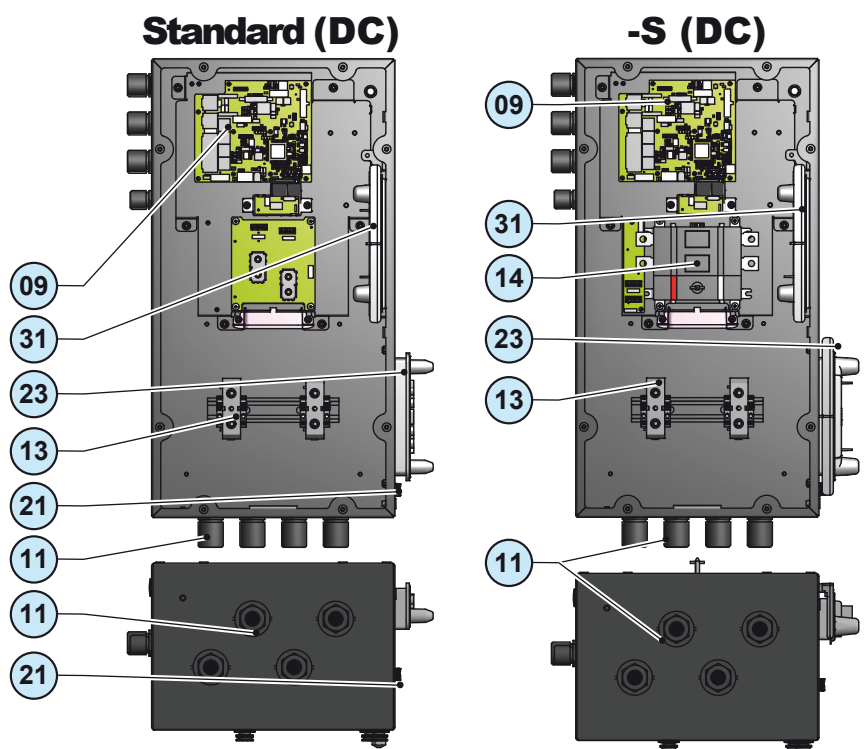

Connection of inputs on the -SX / -SY models

The DCWB-SY is not available for TRIO-60.0-TL-OUTD-480 model

For string connections using the DC ② -SX /-SY wiring box, the quick fit input connectors (MPPT) ⑱ situated at the bottom of the mechanism are used.

The quick fit connectors are divided into 4 groups consisting of:
 -SX Version. 3 or 4 pairs of quick fit connectors according to the model of the wiring box (12 or 16 total connections pairs).
 -SY Version. 3 pairs of quick fit connectors.

The maximum current for each group of inputs (3 or 4 strings depending on the version of the DC wiring box) is 54A.

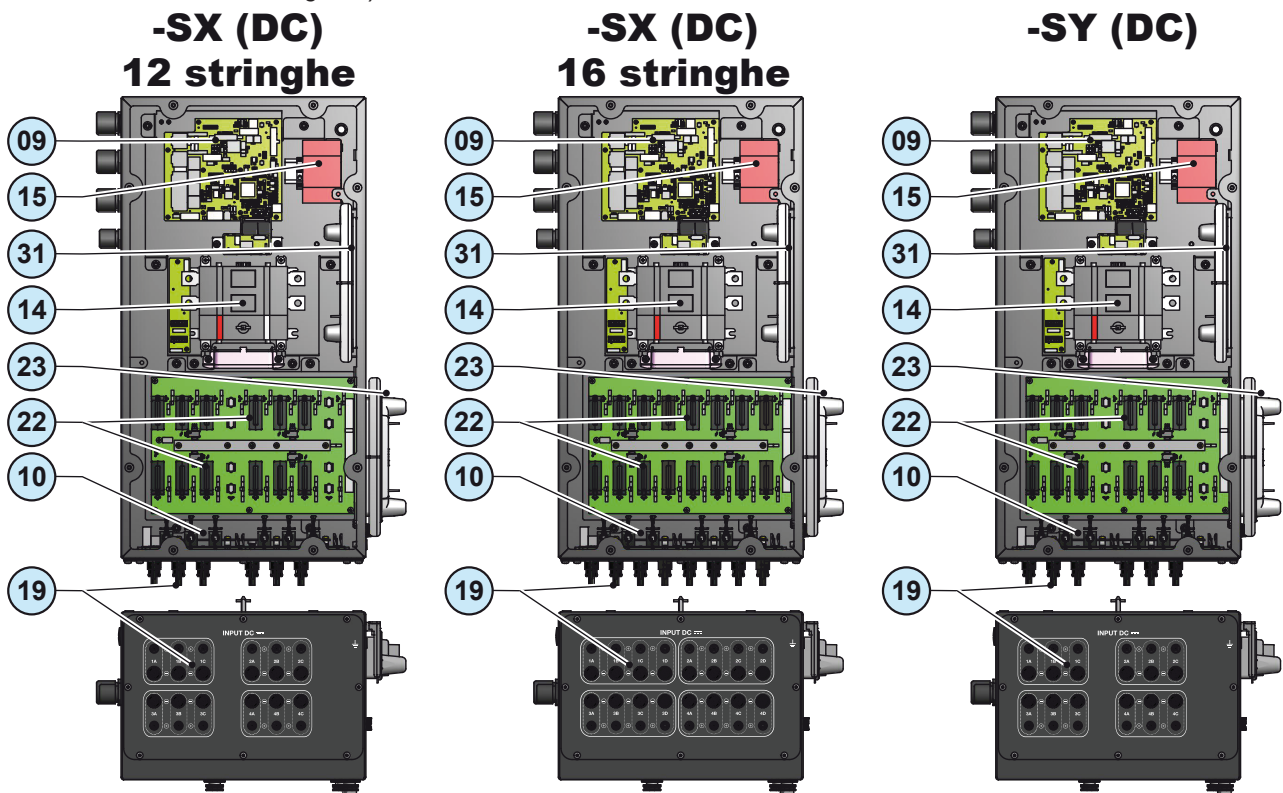

Connect all the strings required by the system, always checking the seal of the connectors.

If any string inputs are not required, you must ensure that covers are installed to the connectors, and install any which are missing.

This is necessary both for the inverter seal, and to avoid damage to the free connector which may be used at a later time.



In these versions of the wiring box, is MANDATORY to directly connect the individual strings coming into the inverter (do not make field switchboards for parallel strings). This is because the ⑩ positive side (+) and ⑳ negative side (-) string fuses, situated on each input, are not rated to take strings in parallel (array). This operation can cause damage to the fuse and consequently malfunctioning of the inverter.

Checking the correct polarity of the strings (-SX / -SY versions)



The DCWB-SY is not available for TRIO-60.0-TL-OUTD-480 model
 These operations are to be carried out using class "0" insulating gloves
 The reverse polarity can cause severe damage.

-SX -SY (DC)

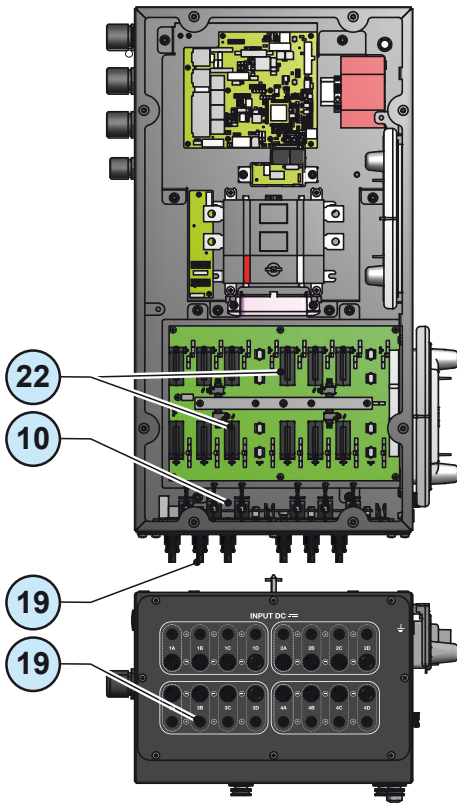

Within the DC wiring box ② installed in inverter models -SX/-SY there are two boards on which the string fuses are installed:

- positive (+) side string fuses ⑩.
- negative (-) side string fuses ②②.

The board installed horizontally on the bottom part of the DC wiring box ② contains the safety fuses on the positive poles ⑩ of the strings connected in input, whereas the board that is installed vertically houses the negative string fuses ②②.

The string safety fuses are installed inside special positioners that allow easy installation/removal, as well as providing protection from involuntary contact while the inverter is being installed.

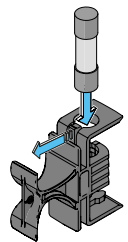

In the -SX and -SY versions 24 or 32 fuses (2 fuses for each string) are predisposed based on the type of wiring box; the series of 12 or 16 fuses on the positive pole (+) are already fitted while the 12 or 16 fuses to be fitted on the negative pole (-) are supplied; each fuse or string is associated with a green LED.

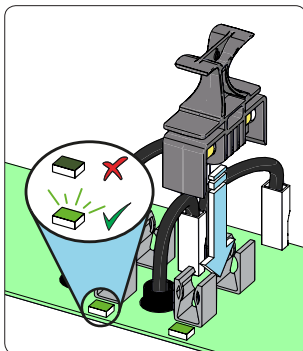

Procedure for checking the correct polarity of the strings

1. Turn the DC disconnect switch ⑭ to OFF
2. Connect the strings and check that the GREEN LED corresponding to each negative fuse activates.

The string will turn out to be inverted if the green LED is off or, in some circumstances, faintly on.

3. Once connected and after all the input strings have been checked, install the negative fuses (supplied). This operation MUST be carried out in safe conditions therefore: Install the fuses using suitable protection (for example, class "0" insulating gloves). Otherwise remove the strings connected in input, install the fuses supplied and connect the strings which have been checked.

4. Close the wiring box cover ①⑧.

5. Install the three conductive spring between the power module cover and the DC wiring box cover, at the unpainted areas.

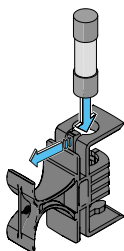

Installation procedure for quick-fit connectors

There are typically four different types of quick-fit connector models used on ABB inverters: Weidmüller PV-Stick or WM4, MultiContact MC4 and Amphenol H4.

Please refer to the document “*String inverters – Product manual appendix*” available at www.abb.com/solarinverters for information on the quick-fit connector brand and model used in the inverter.

The model of connectors installed on your inverter must be matched by the same model of the respective corresponding parts to be used (checking the conforming corresponding part on the manufacturer's website or with ABB).



Using corresponding parts that are not compliant with the quick-fit connector models on the inverter could cause serious damage to the unit and lead to invalidation of the warranty.



CAUTION: To avoid damage to the equipment, when attaching cables, pay particular attention to polarity.



1. WEIDMÜLLER PV-Stick quick-fit connectors

Installation of Weidmüller PV-Stick connectors does not require any special tooling.

- Strip the cable to which you want to apply the connector (after verifying that it complies with the connector limits).

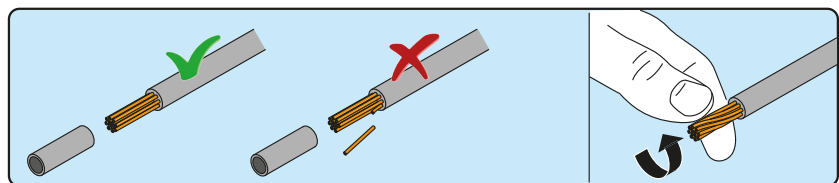
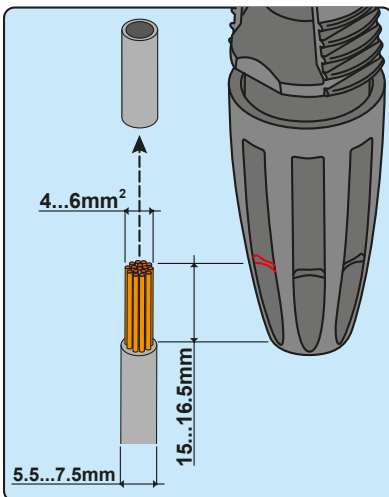

- Insert the wire into the connector until you hear a locking "click".

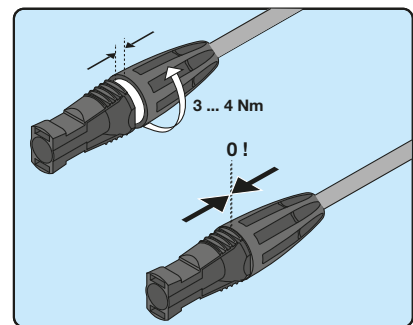
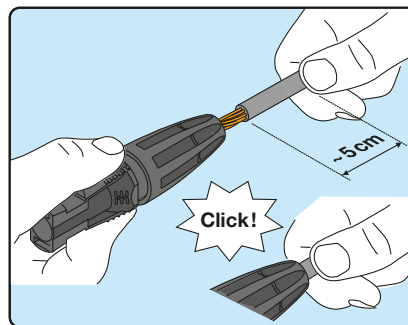

- Tighten the knurled ring nut for optimal clamping.

2. WEIDMÜLLER WM4 quick-fit connectors

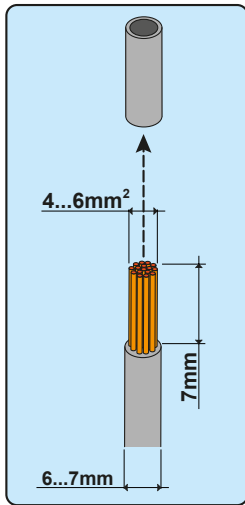

Installation of Weidmüller WM4 connectors requires crimping to be carried out with suitable equipment.

- Strip the cable to which you want to apply the connector (after verifying that it complies with the connector limits).

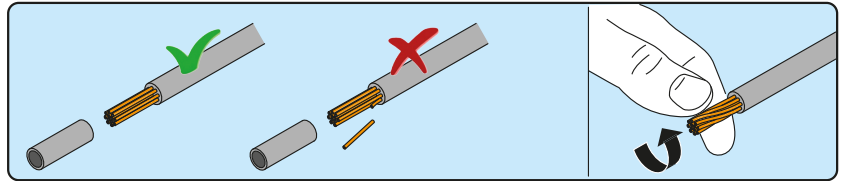

- Apply the terminal to the conductor using the designated pliers.

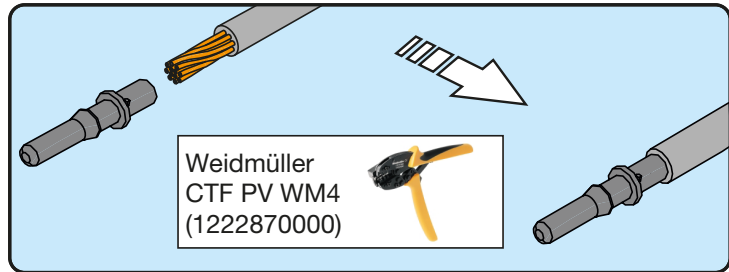

- Insert the cable with the terminal into the interior of the connector, until you hear the click indicating that the terminal is locked inside the connector.

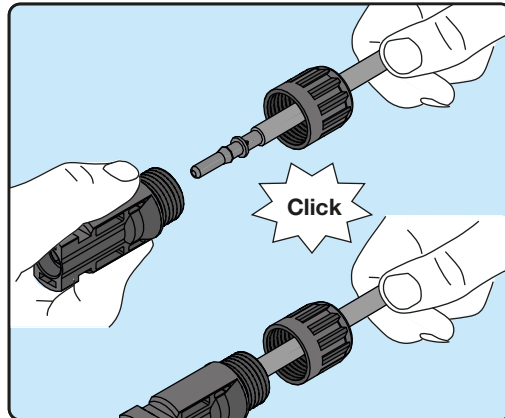

- Firmly tighten the cable gland using the relevant tool to finish the operation.

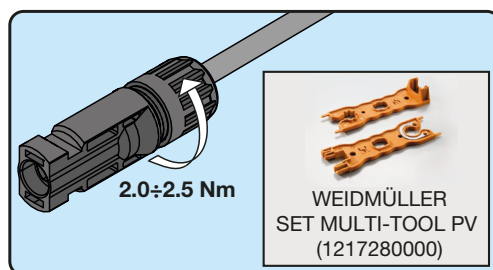

3. MULTICONTACT MC4 quick-fit connectors

Installation of Multicontact MC4 connectors requires crimping to be carried out with suitable equipment.

- Strip the cable to which you want to apply the connector (after verifying that it complies with the connector limits).

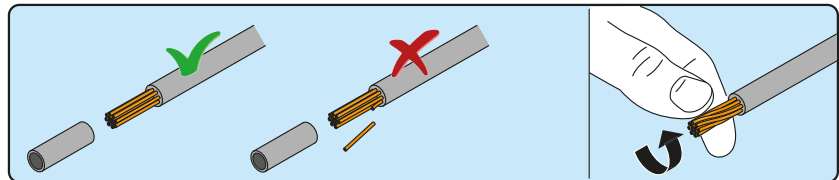
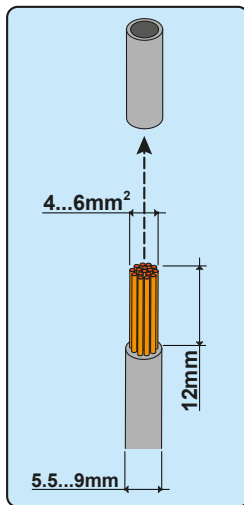

- Apply the terminal to the conductor using the designated pliers.

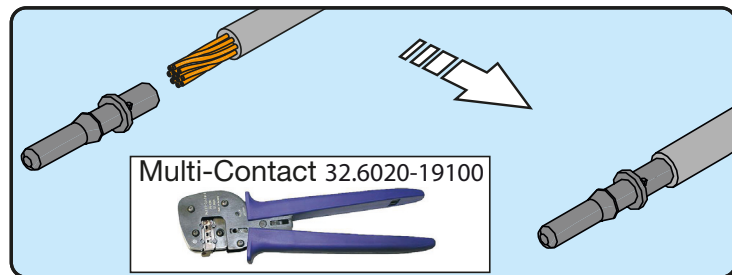

- Insert the cable with the terminal into the interior of the connector, until you hear the click indicating that the terminal is locked inside the connector.

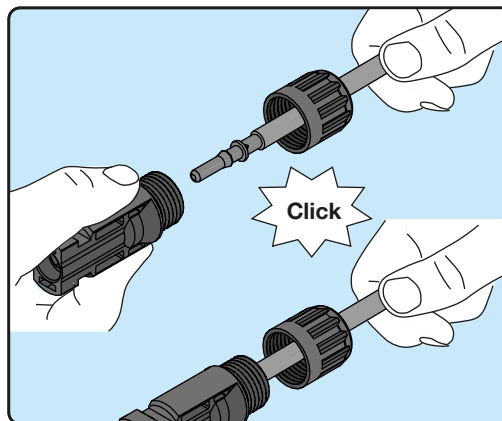

- Firmly tighten the cable gland using the relevant tool to finish the operation.

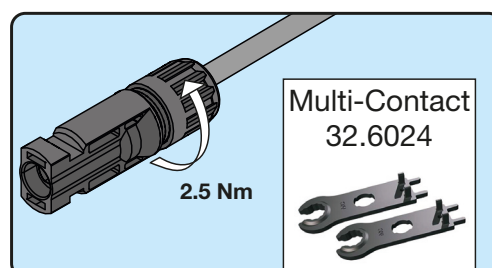

4. AMPHENOL H4 quick-fit connectors

Installation of Amphenol H4 connectors requires crimping to be carried out with suitable equipment.

- Strip the cable to which you want to apply the connector (after verifying that it complies with the connector limits).

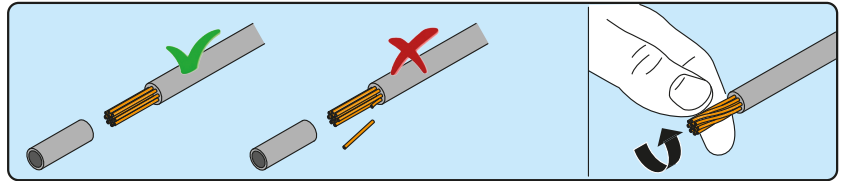
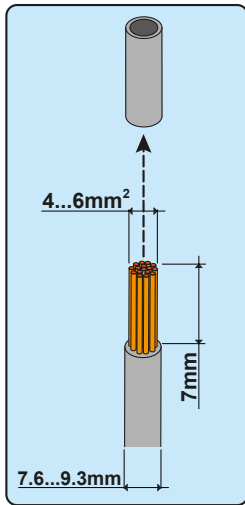

- Apply the terminal to the conductor using the designated pliers.

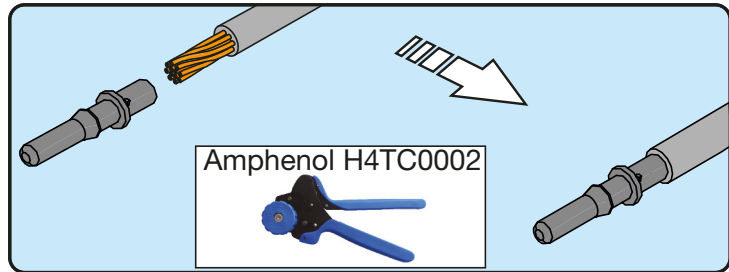

- Insert the cable with the terminal into the interior of the connector, until you hear the click indicating that the terminal is locked inside the connector.

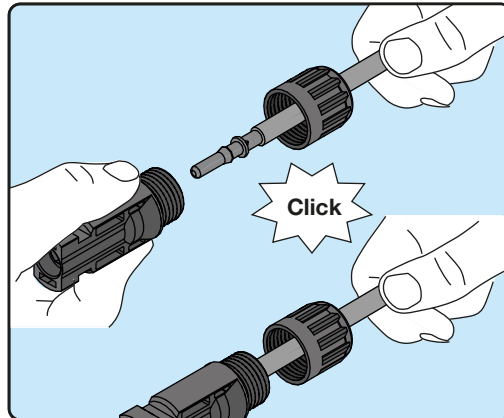

- Firmly tighten the cable gland using the relevant tool to finish the operation.

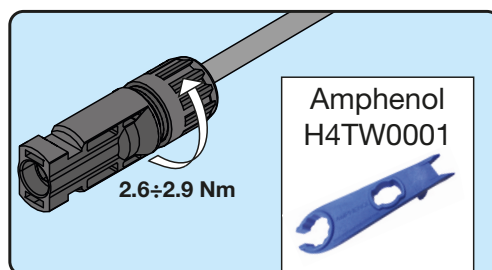

String protection fuses (-SX / -SY models only)

Sizing of fuses

The correct sizing of the ⑩ positive side (+) and ②② negative side (-) string fuses to be used to protect from “return currents” is very important because it can considerably limit the risk of fire and damage to the PV generator. A “return current” can be generated in the event of a fault and relevant short-circuit at the ends of one or more PV modules of the system; this condition can cause all the current supplied by the strings not involved in the fault, but connected to the same input channel, to pass through the faulty string.

SX and SY DC

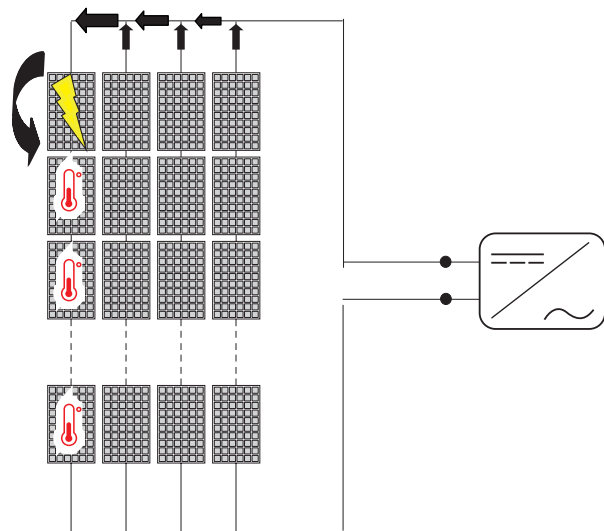
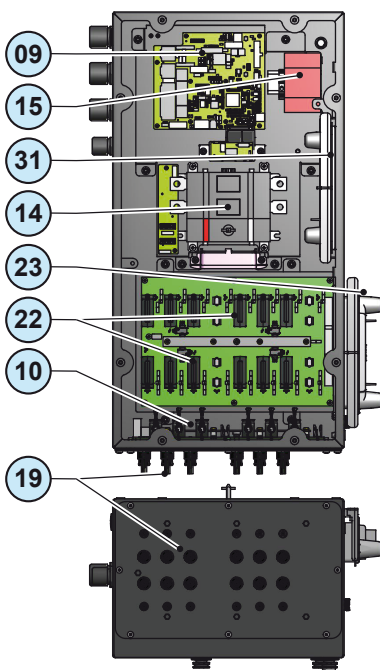

In these versions of the wiring box, you must directly connect the individual strings coming into the inverter (do not make field switchboards for parallel strings). This is because the ⑩ positive side (+) and ②② negative side (-) string fuses, situated on each input, are not rated to take strings in parallel (array).

This operation can cause damage to the fuse and consequently malfunctioning of the inverter.

The sizing of the string fuses must be made taking into account the 2 following conditions:

1. The nominal current of the fuse (I_{rated}) must not exceed the maximum rating of the fuse to be used in series on the strings (maximum series fuse rating), indicated in the technical data of the PV modules in compliance with standard EC 61730-2:

$$I_{rated} < \text{Maximum series fuse rating}$$

2. The fuse rating (I_{rated}) must be determined based on the string current and on the sizing guidelines provided by the manufacturer to avoid untimely tripping. As a general guideline, based on the photovoltaic modules' short circuit current (I_{sc}), it is possible to calculate the rating of the fuse with the following formula:

$$I_{rated} > (1.4 \approx 1.5) \cdot I_{sc}$$

Fuses must be chosen among the standard commercially available ratings, selecting the value that is closest to the obtained result.

The fuse selected with the calculation described previously takes into consideration derating factors and corrections such as:

- increase in the effective irradiation of the installation area
- Increase in the I_{sc} on the basis of the high temperature of the PV module
- Thermal derating of the fuse
- Maximum return current of the PV modules installed

ABB can supply fuse kits of different values

Code	Description	Quantity
KIT 10 FUSES 12A	Kit of 12A fuses	10
KIT 10 FUSES 15A	Kit of 15A fuses	10



For effective calculation taking real installation conditions into account, refer to the documents supplied by the protection fuse manufacturer.



Connections to the communication and control board

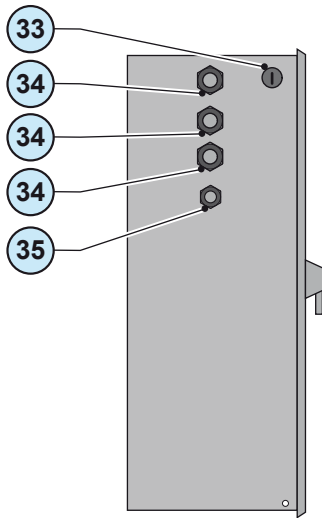

Each cable which must be connected to the communication and control board ⑨ must pass through the following cable glands:

- Three PG21 ③④ that takes cables from 13 mm to 18 mm in diameter. A gasket with two holes is supplied as standard to insert into the PG21 cable gland, which allow two separate cables of a diameter from 1.5 to 6 mm to be accommodated
- One PG16 ③⑤ that take cables from 10 mm to 14 mm in diameter. A gasket with two holes is supplied as standard to insert into the PG16 cable gland, which allow two separate cables of a diameter from 1.5 to 5 mm to be accommodated
- The PG 21 service cable glands ③④ are intended for the RS485 connection.
- The M20 cable gland ③③ is intended for the Wi-Fi antenna connection.

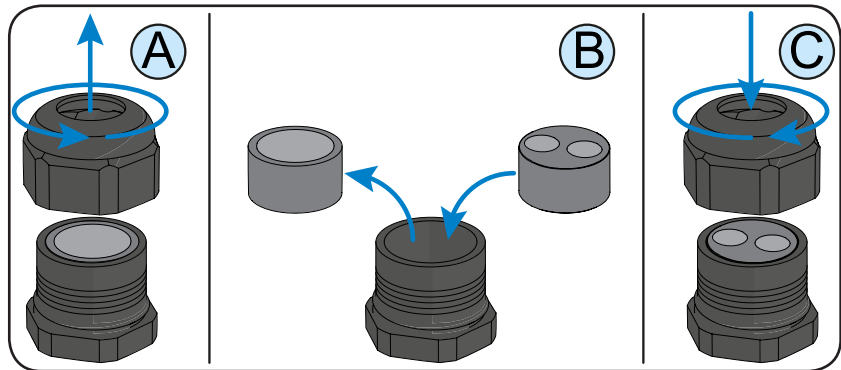

Remote control connection

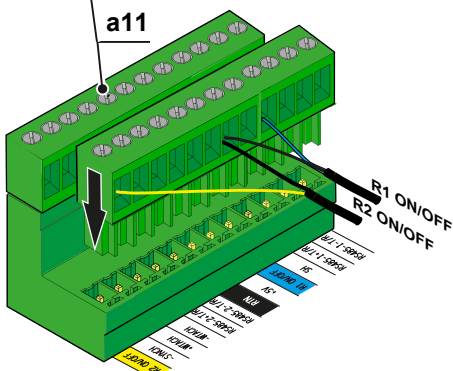
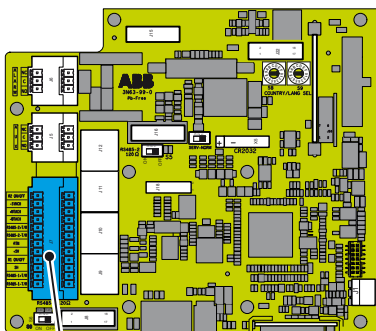

The connection and disconnection of the inverter to and from the grid can be controlled through an external control.

The function must be enabled in the relevant menu through the Aurora Manager Tools software. If the remote control function is disabled, the switching on of the inverter is dictated by the presence of the normal parameters which allow the inverter to connect to the grid.

If the remote control function is operating, besides being dictated by the presence of the normal parameters that allow the inverter to connect to the grid, the switching on of the inverter also depends on the state of the R1 ON/OFF and R2 ON/OFF terminals compared to the RTN terminal present on the a11 connector of the communication and control board ⑨.

When one of the R1 ON/OFF or R2 ON/OFF signals is brought to the same potential as the RTN signal (i.e. by making a short circuit between the two terminals of the connector), this causes the inverter to disconnect from the grid.

The connections of these controls are made between the "R1 ON/OFF" and the "R1 ON/OFF" inputs compared to the common "RTN" signal. Since this is a digital input, there are no requirements to be observed as regards cable cross-section (it only needs to comply with the sizing requirement for passing cables through the cable glands and the terminal connector).

Configurable Relay connection (ALARM and AUX)

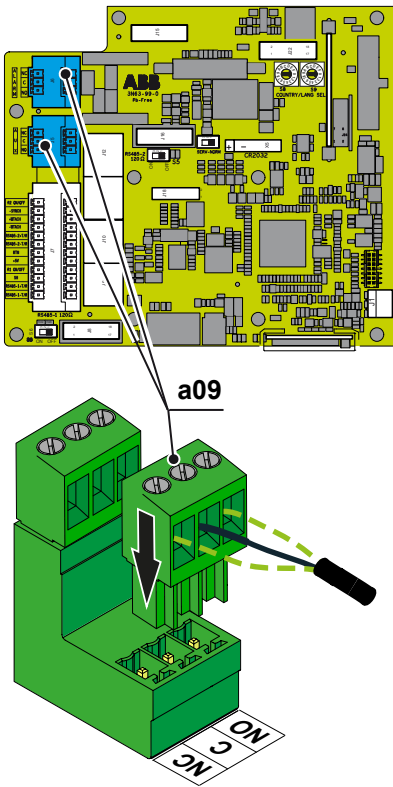

The inverter is equipped with 2 multifunction relays with configurable activation. It can be connected with normally open contact (being connected between the NO terminal and the common contact C) and with normally closed contact (being connected between the NC terminal and the common contact C).

Different types of devices (light, sound, etc.) can be connected to the relay, provided they comply with the following requirements:

Alternating current

Maximum Voltage: 240 V AC

Maximum Current: 1 A

Direct current

Maximum Voltage: 30 V DC

Maximum Current: 0.8 A

Cable requirements

External diameter: from 5 to 17 mm

Conductor cross-section: from 0.14 to 1.5 mm²

This contact can be used in different operating configurations that can be selected by accessing the Aurora Manager Tools software,

Connector for expansion board installation (optionals)

The inverter is equipped with a dedicated a02 (J15) connector for installation of the expansion boards (optionals).

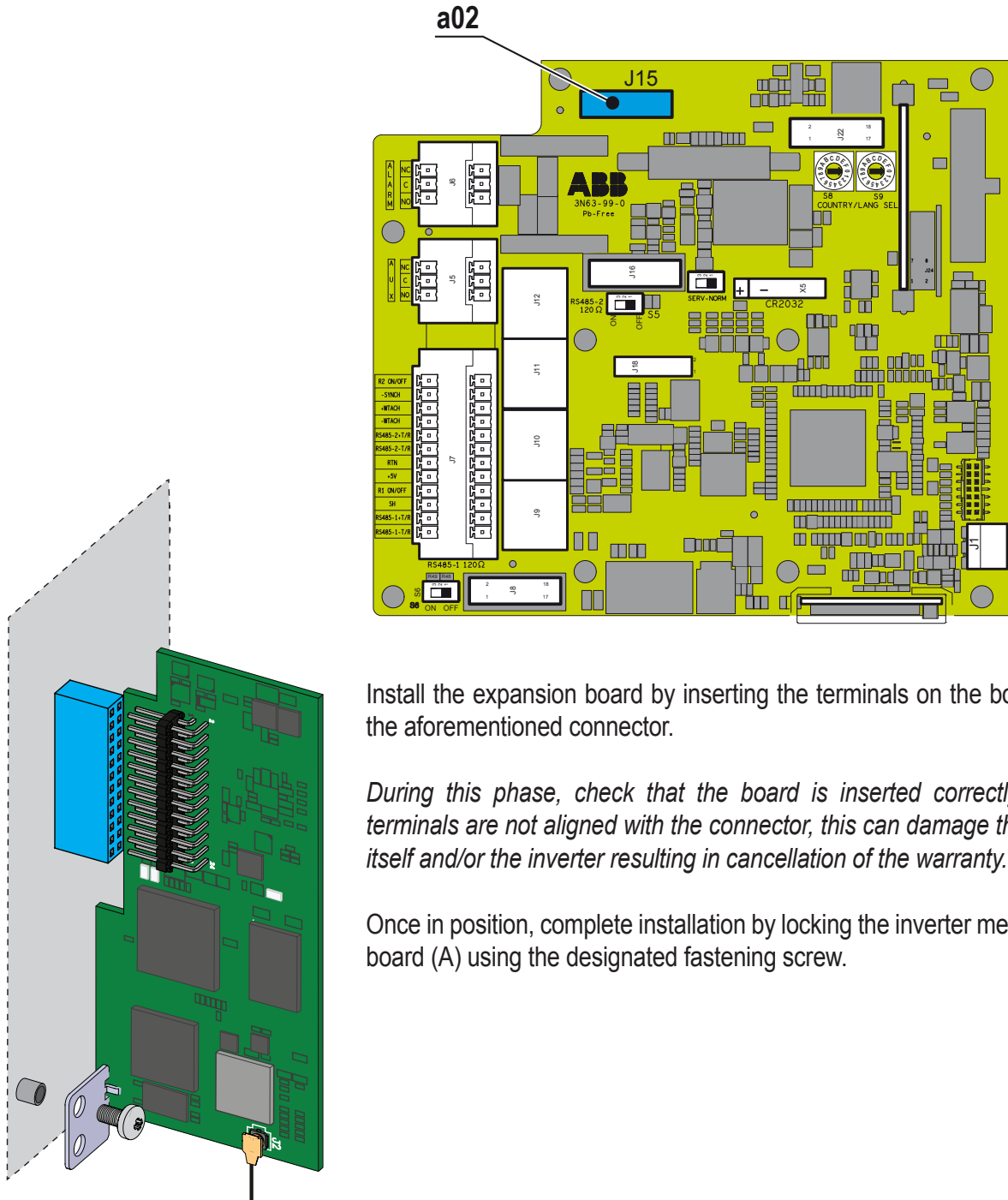

Install the expansion board by inserting the terminals on the board into the aforementioned connector.

During this phase, check that the board is inserted correctly. If the terminals are not aligned with the connector, this can damage the board itself and/or the inverter resulting in cancellation of the warranty.

Once in position, complete installation by locking the inverter mechanical board (A) using the designated fastening screw.

Serial Communication connection (RS485)

The inverter has two RS485 communication lines with the communication protocol which can be set in "Aurora" (proprietary communication protocol) or ModBus (public communication protocol). The default configuration of the protocol for both communication ports is "Aurora" which can be changed through the advanced "Aurora Manager LITE" configuration software.

Both RS485 lines can be used to:

- connecting the inverter to monitoring devices
- carry out configuration operations using the "Aurora Manager LITE" configuration software.
- sending power management commands

The two lines only differ in terms of the firmware upgrading (locally or remotely through the ABB monitoring devices) which **must** be carried out by connecting to the RS485 (1) port

When connecting the ABB monitoring devices, the RS485(1) line must be used

Cables connecting the RS485 line may use two different types of connection:

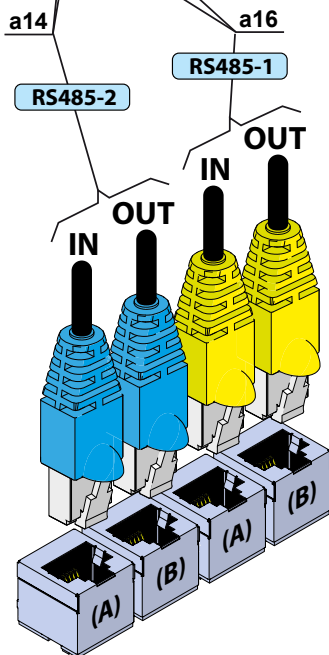
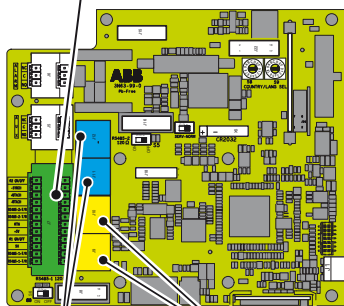
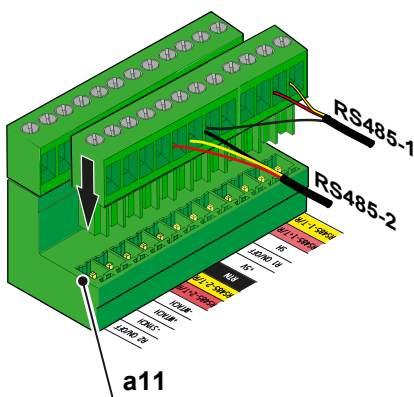

- **Connection of the conductors using the terminal connectors a11 (+T/R, -T/R, RTN e SH)**

The SH connection must be used for connecting the shielding boot(s) of the cable(s).

- **Connection of conductors with RJ45 connectors a14 or a16**

The two RJ45 connectors (A) and (B) available for the RS485 communication, are equivalent to each other and can be used interchangeably for the arrival or for the output of the line in realising the daisy chain connection of the inverters.

Table: crimping diagram for RJ45 connectors

Pin No.	Function
3	+T/R
5	-T/R
7	RTN
1, 2, 4, 6, 8	not used

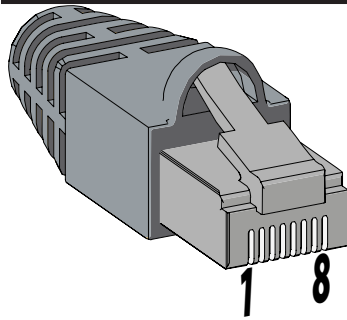

Use a connector with metal body to provide cable shield continuity!

For long distance connections, the connection on terminal connector is preferable using a shielded twisted pair cable with characteristic impedance of $Z_0=120$ Ohm like the one shown on the following table:

Signal	Symbol
Positive data	+T/R
Negative data	-T/R
Reference	RTN
Screen	SH

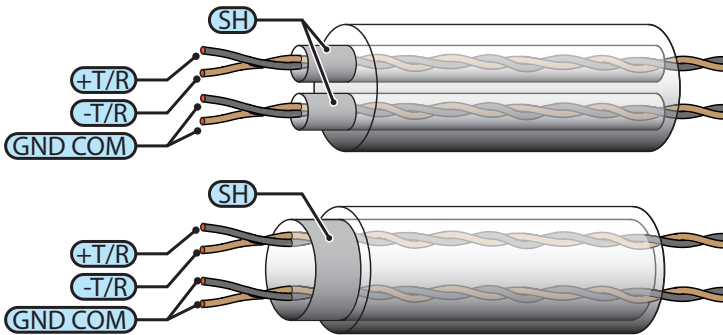

Shield continuity must be provided along the communication line using the SH terminal and must be grounded at a single point.

Monitoring and control systems

The RS485 line can be used to set up a line of communication (with the communication protocol which can be set in "Aurora" or "ModBus") which, when connected to a monitoring device, enables the operation of the photovoltaic system to be kept under control. Depending on the device used monitoring can be local or remote.

Any ABB monitoring devices must be wired to the RS485(1) port



For information on installation, compatibility and use please refer to the specific documentation on the accessory components.

Procedure for RS485 connection to a monitoring system

Connect all the units of the RS485 chain in accordance with the daisy-chain model observing the correspondence between the signals, and activate the termination resistance of the communication line in the final element of the chain by switching the **a12** or **a13** switch respectively on the basis of the RS 485 (1) and RS 485 (2) line in the ON position.

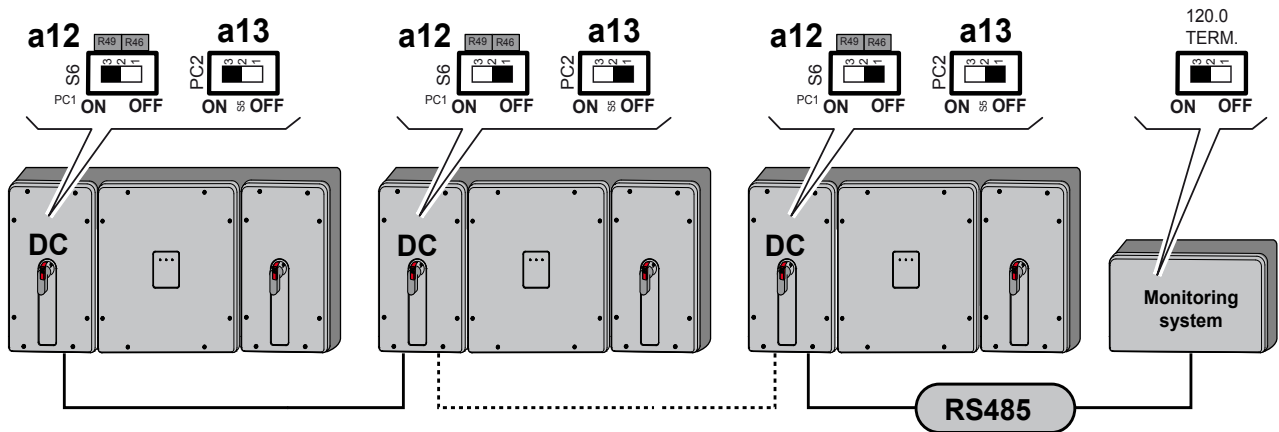

The communication line must also be terminated on the first element of the chain which normally corresponds to the monitoring device.



It is recommended not to exceed a length of 1000m for the communication line. The maximum number of inverters that can be connected to the same RS485 line is 62.

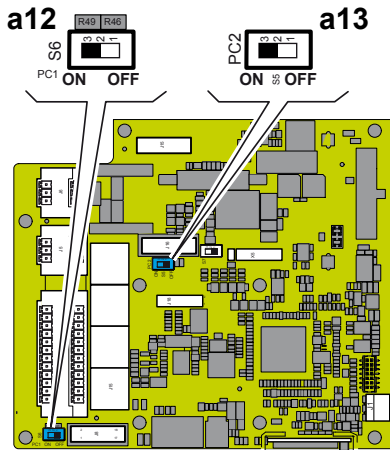

When connecting a single inverter to the monitoring system, activate the communication line resistance terminal by setting the switch **a12** or **a13** (to the ON position).

Set a different RS485 address on each inverter in the chain. **No inverter can have "Auto" as an address.** An address can be freely chosen between 2 and 63.

The setting of the address on the inverter is done through the "Aurora Manager" software.

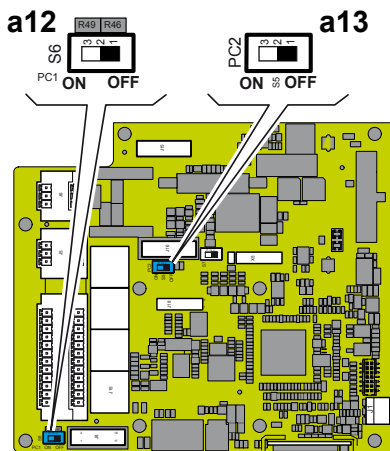

When an RS-485 connection is being used, if one or more inverters are added to the system at a later time, it is necessary to remember to reset to OFF the switch on the termination resistance being used (1) or (2) on the inverter which previously was the last in the system.

Each inverter is shipped with the RS485 address pre-set to two (2) and with the resistance terminal setting Switch **a12** or **a13** in the OFF position.

General conditions

One of the first rules for preventing damage to the equipment and to the operator is to have a thorough knowledge of the instruments. We, therefore, advise that you carefully read this manual. If you are not sure about any information in this manual, please ask ABB Service for more detailed information.



Do not use the equipment if:

- you do not have suitable qualifications to work on this equipment or similar products;*
- you are unable to understand how it works;*
- you are not sure what will happen when the buttons or switches are operated;*
- you notice any operating anomalies;*
- there are doubts or contradictions between your experience, the manual and/or other operators.*

ABB cannot be held responsible for damage to the equipment or the operator if it is the result of lack of knowledge, insufficient qualifications or lack of training.

Description of the LED function

The LED functions on the inverter are described below.

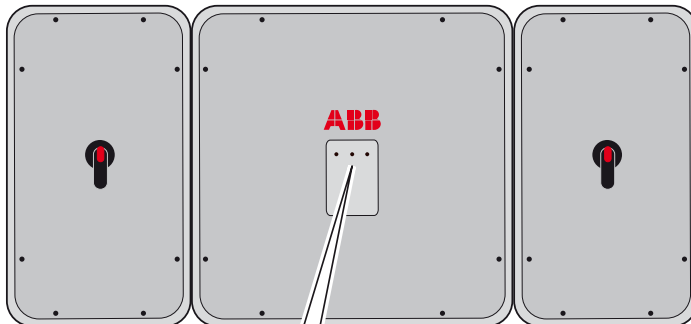

GREEN

Indicates that the inverter is functioning correctly.

When the unit is commissioned, while the grid is checked, this LED blinks. If a valid grid voltage is detected, the LED remains continuously lit, as long as there is sufficient sunlight to activate the unit. Otherwise, the LED will continue to blink until the sunlight is sufficient for activation.

The LEDs, in various multiple available combinations, can signal multiple conditions other than the original single condition; see the various descriptions explained in the software manual.

YELLOW

Indicates that the inverter has detected an anomaly. This type of problem is highlighted through the "Aurora Manager Lite" software.

RED

The "GFI" (ground fault) LED indicates that the inverter has detected a ground fault in the DC side photovoltaic generator. When this fault is detected, the inverter immediately disconnects from the grid.

LED insulation fault

Interventions after warning of insulation fault

When the red LED activates, first of all try to reset the alarm using the "Aurora Manager Lite" software.

If the inverter reconnects normally to the network the fault was due to temporary phenomena.

You are advised to have the plant inspected by the installer or a specialist should this malfunction occur repeatedly.

If the inverter does not reconnect to the grid, isolate it on both the AC and DC sides (by using the disconnect switches), then contact the installer or authorised centre to repair the fault in the photovoltaic generator.

Aurora Manager LITE - Advanced configuration software

For the characteristics and functions that Aurora Manager LITE makes available is indicated for:

1. Local monitoring of the inverter.

It is possible to monitor the main parameters relating to:

- General state
- Statistical data relating to the production of energy
- Input and output values
- Internal temperature
- Values relating to the insulation of the photovoltaic generator
- Date and time

2. Advanced configuration of the inverter (INSTALLER access level):

Offers the option of applying advanced settings for the inverter. Access to this section of the software is password protected as it permits the modification of sensitive parameters such as those relating to the standard for connection to the grid in force in the country of installation.

The password can be obtained by registering on the site <https://registration.abbsolarinverters.com/>



3. Updating of the inverter firmware.

Updating the inverter Firmware is process which may become necessary to improve the performance of the inverter or increase its functions.

In order to use the software a connection must be established between the PC and the inverter (by means of an RS485 communication line) using a PVI-USB-RS485_232 signal converter.

In all cases, the use of ABB products is recommended to avoid problems of incompatibility with the inverter.



General conditions

Before checking the operation of the equipment, it is necessary to have a thorough knowledge of the Instruments chapter 6 and the functions that have been enabled in the installation process.

The equipment operates automatically without the aid of an operator; the operating state should be controlled through the equipment's instrumentation.

The interpretation or variation of some data is reserved exclusively for specialized and qualified staff.



*The incoming voltage must not exceed the maximum values shown in the technical data, section 2 in order to avoid damaging the equipment.
Consult the technical data for further details.*

During operation, check that the environmental and logistical conditions are correct (see installation chapter 5).

Make sure that environmental and logistical conditions have not changed over time and that the equipment is not exposed to adverse weather conditions.

Monitoring and data transmission

As a rule, the inverter operates automatically and does not require special checks. When there is not enough solar radiation to supply power for export to the grid (e.g. during the night), it disconnects automatically and goes into stand-by mode.

The operating cycle is automatically restored when there is sufficient solar radiation. At this point, the luminous LEDs on the LED panel will indicate this state.

User interface mode

The inverter is able to provide information about its operation through the following instruments:

- Warning lights (luminous LEDs)
- Data transmission on the dedicated RS485 serial line. The data can be collected by a PC or a data logger equipped with an RS485 port. Contact the ABB support service with any queries about device compatibility.

Types of data available

The inverter provides two types of data, which can be retrieved through the special interface software.

Real-time operating data

Real-time operating data can be transmitted on request through the communication lines and are not recorded in the inverter.

Internally stored data

The inverter internally stores a set of data that is necessary for processing statistical data and an error log with time marking.



Measurement tolerance

The data supplied by the inverter may differ from measurements taken by certified measuring instruments (e.g. output meters, multimeters and grid analysers); since the inverter is not a measuring instrument it has wider tolerances for the measurements it makes.

The tolerances are generally:

±5% for real-time measurements with output power below 20% of nominal power

±3% for real-time measurements with output power above 20% of nominal power

±4% for all statistical data.

Preliminary operations before commissioning

In order to commission the inverter it is necessary to carry out certain preliminary operations to ensure the inverter operates properly.

Setting the national grid standard

According to the country in which the inverter is installed there are different grid parameters (dictated by the distributor).



It is essential that you set the grid standard for the country of installation before commissioning, and the installer must be aware of the correct standard to be set.

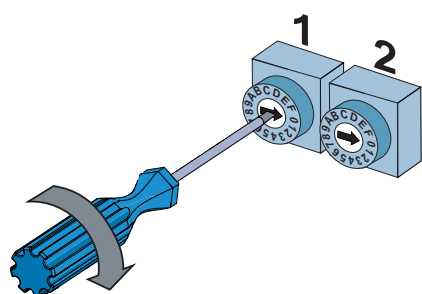
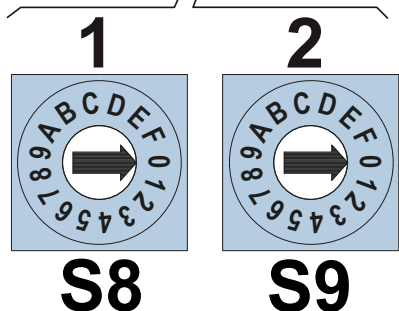
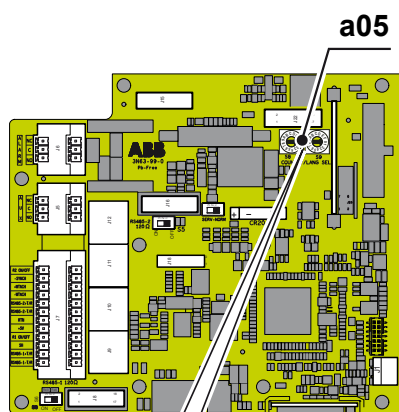

Switch		Country Grid Standard	
1	2	TRIO-50.0-TL-OUTD	TRIO-60.0-TL-OUTD-480
0	0	NOT ASSIGNED	NOT ASSIGNED
0	1	GERMANY VDE 0126@400V	GERMANY VDE 0126@480V
0	6	SPAIN RD413 @ 400V	-
0	8	UK - G59 @ 400V	UK - G59 @ 480V
0	9	IRELAND @ 400V	-
0	A	AUSTRALIA @ 400V	AUSTRALIA @ 480V
0	B	ISRAEL @ 400V	-
0	C	GERMANY - BDEW @ 400V	GERMANY - BDEW @ 480V
0	E	NETHERLANDS @ 400V	-
0	F	GREECE @ 400V	GREECE @ 480V
1	0	PORTUGAL @ 400V	-
1	1	CORSICA @ 400V	CORSICA @ 480V
1	2	HUNGARY @ 400V	-
1	3	CHINA LV @ 400V	-
1	4	KOREA @ 380V	-
1	5	TAIWAN @ 380V	-
1	6	CHECA Republic @ 400V	CHECA Republic @ 480V
1	7	GERMANY-VDE AR-N-4105@400V	-
1	8	CEI-021@400V EXTERNAL Prot.	-
1	B	SOUTH AFRICA @ 400V	-
1	C	SPAGIN RD 1565 @ 400V	-
1	D	BELG C10-11 100% @ 400V	-
1	F	BRAZIL @ 380V	BRAZIL @ 480V
2	0	TURKEY LV @ 400V	-
2	1	ROMANIA @400V	-
2	2	SLOVENIA @400V	-
2	3	TURKEY HV @ 400V	TURKEY HV @480V
2	4	CEI-016 @ 400V	CEI-016 @ 480V
2	5	EN50438 generic @ 400V	-
2	8	FRANCE LL 2014 @ 400V	FRANCE LL 2014 @ 480V
2	9	THAILAND MEA @ 400V	-
2	A	INDIA @ 400V	-
2	D	THAILAND PEA @ 380V	-

Switch		Country Grid Standard	
1	2	TRIO-50.0-TL-OUTD	TRIO-60.0-TL-OUTD-480
2	E	SINGAPORE @ 400V	-
2	F	CHINA HV @ 400V	-
3	0	DENMARK TR-B @ 400V	-
3	6	DUBAI MV	-
3	7	DUBAI LV EX	-
3	C	JORDAN @ 400V	JORDAN @ 480V
3	D	-	MEXICO @ 480V
3	E	CHILE MV @ 400V	-
3	F	IEC 62116 @ 400V	IEC 62116 @ 480V

The inverter is configured using the rotary switches a05. Before adjusting the rotating switches, make sure that the inverter is turned off! The table shows which country grid standard and which menu language are assigned to the various positions of rotary switches a05



The list of grid standards provided in the table was valid at the time of issue of the manual. It will be continually updated as new country grid standards with which the inverter is compatible are introduced.

If the grid standard for the country of installation is not on the list, its presence can be checked using the "Aurora Manager Lite" software when the inverter is first switched on. Then turn the switches a05, and the grid standard for the position set will be displayed.



During this phase the inverter is on, so pay particular attention and always wear suitable protective equipment (for example, Class 0 Category RC insulating gloves).

The default setting is on **0 / 0** and means that there is no grid standard selected.



Saving the country grid standard and language

The settings are frozen after the inverter has been in operation for 24 hours (it does not matter whether or not it is connected to the grid, it only has to be under power).

The time remaining before the settings are frozen can be viewed using the "Aurora Manager Lite" software.

Once the settings have been frozen nothing will happen if the rotating switches are turned.

Installing the Wiring Box cover and conductive springs

When you have finished connecting and configuring the inverter, and before commissioning, the front covers ⑧ of the AC and DC wiring boxes must be fitted as well as the cover of the inverter itself.

IP65

During the installation of the cover must be observed the sequence and the tightening torque of the screws 8 in order to maintain the IP rating of the inverter

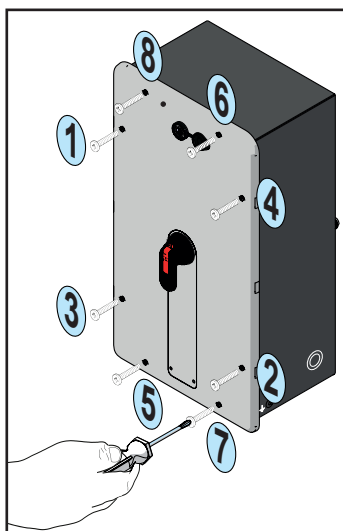

- Confirm the disconnect switches on the cover are OFF
- Carefully place the cover over the wiring box.
- Reinstall the cover screws following the order shown in the figure; torque to 2.4 Nm

Also fit the 6 conductor springs ⑳ which serve to reduce the irradiated electrical noise.

Note: The conductor springs must be inserted between the covers in the unpainted areas.

The springs are fitted as follows:

1. compress the spring
2. insert the spring between the two covers
3. release the spring

Inverter commissioning can start once the Wiring Box covers have been fitted.

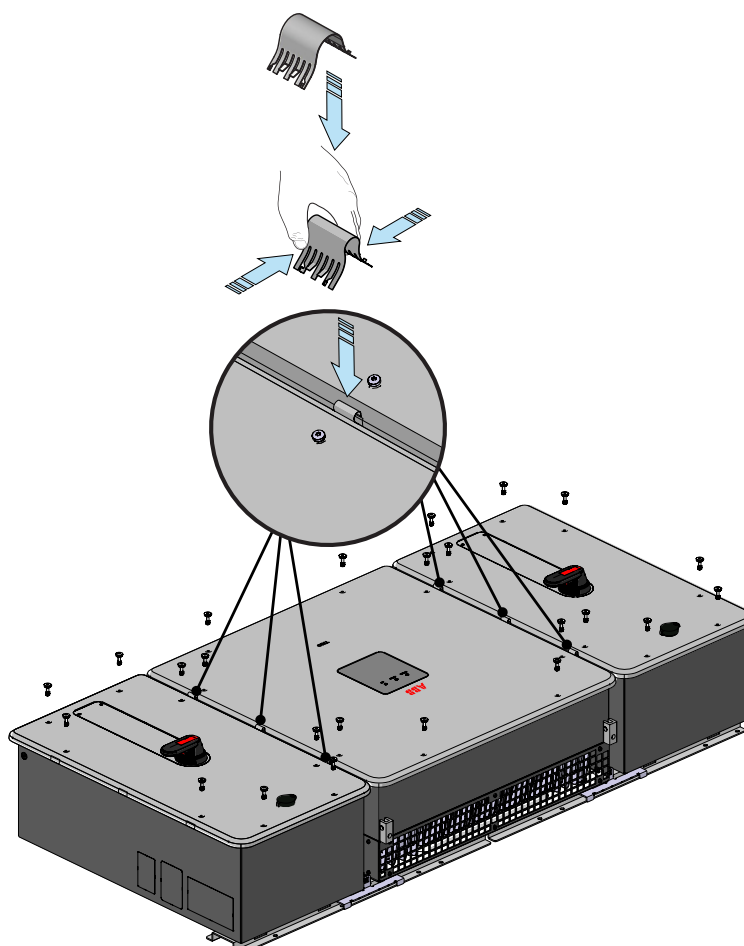

Commissioning



*Do not place objects of any kind on the inverter during operation!
Do not touch the heat sink while the inverter is operating!
Some parts may be very hot and could cause burns.*



Before proceeding with commissioning, make sure you have carried out all the checks and verifications indicated in the preliminary checks section.

Pre commissioning inspection

Before commissioning the inverter confirm that all installation procedures have been completed. In particular:

- confirm the grid standard have been setted
- confirm the grid type (3WIRES/4WIRES) have been setted
- confirm the covers are well installed
- confirm all cover screws were reinstalled and torqued
- leave the disconnects OFF
- confirm all the openings (cable gland, quick fit connectors, etc.) are sealed and water tight
- confirm the disconnect switches (external and on the inverter) are open

Commissioning procedure



The commissioning procedure of the inverter is as follows.

- Close (turn ON) the internal and/or external DC disconnect switch. Watch for the green "Power" LED to begin flashing a few seconds after the DC disconnect is closed.
- Wait for the yellow "alarm" LED to light up and remain on, indicating there is no AC mains.
- Close (turn ON) the internal and/or external AC disconnect switch.
- Watch for the yellow LED to turn off, while the green LED continues to flash while the inverter runs self-tests and grid checks. The time required varies from ~30 seconds to a few minutes, depending on the grid condition and standards.

During the initialization phase the inverter may automatically run some firmware updates in its various microprocessors; during this phase, the LED will flash in sequence. Await the conclusion of this operation which will be highlighted by the rapid flashing three times, the LEDs.

- Watch for the green LED to stop flashing remain ON if when self-tests and grid checks are complete and the inverter starts production.

Any configuration of the inverter must be carried out through Aurora Manager LITE software. The software and its own manual are available at www.abb.com/solarinverters.

Possible LEDs behaviour are described in the following paragraph.

Enabling and default parameters

These main parameters are preset by the Manufacturer and can be modified using the Aurora Manager Lite software.

- **Date and time:** It is set to UTC (daylight saving time is NOT considered).
- **RS485 address:**
RS485 (1) default setting on AUTO
RS485 (2) default setting on AUTO
- **Vstart:** 420 V
- **Configurable relay (ALARM):** default setting on "PRODUCTION"
- **Remote control:** OFF
- **UV Protection Time:** 60 sec.
- **Reactive power:** NO regulation.
- **MPPT scan:** ON (active) allows maximum power point tracking to be carried out.
- **Power reduction:** 100%. No power limit activated.





























LED behaviour















The LEDs on the front panel may behave in different ways depending on the inverter's operational status.

All possible LED activation combinations are shown in the following table. In particular, each LED could behave in one of the following ways:

- = LED on
- ⊗ = LED flashing slow (2 seconds on / 2 seconds off)
- ⊗ = LED flashing fast (0.2 seconds on / 0.2 seconds off)
- = LED off
- ⊗ = Any one of the conditions described above

LED status	Operating state
green:  yellow:  red: 	Firmware programming The inverter firmware is being programmed
green:  yellow:  red: 	Night mode (inverter automatically switches off) The inverter is in night time switch-off mode (input voltage less than 70% of the set start-up voltage).
green:  yellow:  red: 	Inverter initialization This is a transitional state due to verification of the operating conditions. During this stage the inverter checks that the conditions for connecting to the grid are met.
green:  yellow:  red: 	The inverter is connected and is feeding power into the grid Normal operation. During this stage, the inverter automatically tracks and analyses the photovoltaic generator's maximum power point (MPP).
green:  yellow:  red: 	Disconnection from the grid Indicates lack of grid voltage. This condition does not allow the inverter to connect to the grid (the inverter display shows the message "Missing Grid").
green:  yellow:  red: 	Warning indication: (W message codes) or Error: (E message codes) - Indicates that the inverter control system has detected a warning (W) or error (E). It is possible to identify the type of problem generated with the Aurora Manager LITE software (see the alarm messages).
green:  yellow:  red: 	Temperature protection trip Indicates that the trip relating to internal temperatures (insufficient or excessive temperature) may have been activated
green:  yellow:  red: 	Anomaly in the insulation system of the photovoltaic generator Indicates that a leakage to earth from the PV generator has been detected, causing the inverter to disconnect from the grid.
green:  yellow:  red: 	• Front cover open The sensors located inside the wiring box are warning that one or both of the front covers is missing or not correctly installed. This condition prevents the commissioning of the equipment.



LED status	Operating state
green:  yellow:  red: 	<ul style="list-style-type: none"> • Ventilation anomaly Indicates an anomaly in the operation of the internal ventilation system that could limit output power at high ambient temperatures.
	<ul style="list-style-type: none"> • Failed association of internal inverter components (after replacement) Indicates that the installed wiring box (only in the event of a replacement) was already associated with another inverter and cannot be associated with the new inverter
	<ul style="list-style-type: none"> • Overvoltage surge arresters triggered (where fitted) Indicates that any class II overvoltage surge arresters installed on the AC or DC side have been triggered
	<ul style="list-style-type: none"> • String protection fuses triggered (where fitted) Indicates that one or more input string protection fuses that may be installed have been triggered
	<ul style="list-style-type: none"> • Autotest not executed (only for Italian network standards) On the inverter was not performed the Autotest
	<ul style="list-style-type: none"> • Internal statistics memory anomaly Indicates an operating anomaly in the internal memory on which the inverter statistics are stored
	<ul style="list-style-type: none"> • Buffer battery discharged The buffer battery is low and the inverter does not maintain the time setting
green:  yellow:  red: 	<ul style="list-style-type: none"> • Initial configuration failure The inverter is in locked state due to a failure in the initial configuration of the equipment, such as the standard network setting for the country of installation
	<ul style="list-style-type: none"> • Self-test not carried out (for Italian grid standards only) Self-test operation failure
	<ul style="list-style-type: none"> • Incompatibility of the device firmware versions The firmware versions of the various devices comprising the equipment are incompatible and are being updated (this is an automatic operation)
	<ul style="list-style-type: none"> • Temperature sensor anomaly detected
green:  yellow:  red: 	<ul style="list-style-type: none"> • Updating the firmware from an SD card The equipment firmware is being updated from an SD card
* lighting of the LEDs in sequence	<ul style="list-style-type: none"> • Firmware programming failure There has been a failure in programming the firmware, of one or more internal devices of the equipment, to the equipment from an SD card.
green:  yellow:  red: 	<ul style="list-style-type: none"> • Updating the firmware from an SD card completed The equipment firmware has been successfully updated from an SD card
green:  yellow:  red: 	<ul style="list-style-type: none"> • Updating the firmware from an SD card has failed The equipment firmware update from an SD card has failed
*blink 3 times	<ul style="list-style-type: none"> • Remote OFF activated The Remote Off command has been activated. The unit will not connect to the network until the remote ON command has been activated

Setting Parameters

Changing certain parameters may prevent disconnection from the grid if the new values exceed those given in the standards of the country of installation. If these parameters are changed to values outside the standard range, an interface protection must be installed external to the inverter in accordance with the requirements of the country of installation.

These parameters can only be displayed with the Aurora manager Lite interface SW.

The table below shows the parameters that can be changed and the range of values that may be set for each:

Parameter	Description	Setting range
Set U>>	Grid over-voltage (OV) threshold (extended range)	Unom ... Unom x 1.3
Set U<<	Grid under-voltage (UV) threshold (extended range)	10V ... Unom
Set F>>	Grid over-frequency (OF) threshold (extended range)	Fnom ... Fnom + 5Hz
Set F<<	Grid under-frequency (UF) threshold (extended range)	Fnom - 5Hz ... Fnom
Set U>	Grid over-voltage (OV) threshold (restricted range)	Unom ... Unom x 1.3
Set U> (10Min)	Over-voltage (OV) threshold (average grid voltage value)	Unom ... Unom x 1.3
Set U<	Grid under-voltage (UV) threshold (restricted range)	10V ... Unom
Set F>	Grid over-frequency (OF) threshold (restricted range)	Fnom ... Fnom + 5Hz
Set F<	Grid under-frequency (UF) threshold (restricted range)	Fnom - 5Hz ... Fnom
Set Uconn>	Max. permissible voltage during checks prior to grid connection	Unom ... Unom x 1.3
Set Uconn<	Min. permissible voltage during checks prior to grid connection	10V ... Unom
Set Fconn>	Max. permissible frequency during checks prior to grid connection	Fnom ... Fnom + 5Hz
Set Fconn<	Min. permissible frequency during checks prior to grid connection	Fnom - 5Hz ... Fnom
Set Time U>>	Over-voltage U>> protection tripping time	0 ... 327670mS
Set Time U<<	Under-voltage U<< protection tripping time	0 ... 327670mS
Set Time F>>	Over-frequency F>> protection tripping time	0 ... 327670mS
Set Time F<<	Under-frequency F<< protection tripping time	0 ... 327670mS
Set Time U>	Over-voltage U> protection tripping time	0 ... 327670mS
Set Time U<	Under-voltage U< protection tripping time	0 ... 327670mS
Set Time F>	Over-frequency F> protection tripping time	0 ... 327670mS
Set Time F<	Under-frequency F< protection tripping time	0 ... 327670mS
Set time conn 1	Grid check time prior to connection	0 ... 65535mS
Set time conn 2	Grid check time prior to connection after a grid fault	0 ... 65535mS
Disable U>>	Disables the U>> protection threshold	Enabled/Disabled
Disable U<<	Disables the U<< protection threshold	Enabled/Disabled
Disable F>>	Disables the F>> protection threshold	Enabled/Disabled
Disable F<<	Disables the F<< protection threshold	Enabled/Disabled
Disable U>	Disables the U> protection threshold	Enabled/Disabled
Disable U> (10Min)	Disables the U> (10Min) protection threshold	Enabled/Disabled
Disable U<	Disables the U< protection threshold	Enabled/Disabled
Disable F>	Disables the F> protection threshold	Enabled/Disabled
Disable F<	Disables the F< protection threshold	Enabled/Disabled
U> (10Min) Der.	Enables power derating mode due to high average grid voltage readings	Enabled/Disabled
Slow Ramp	Enables gradual ramping up of power after the grid connection.	Enabled/Disabled
OF Derating	Selects the power derating mode in the event of grid over-frequency.	0 Derating disabled 1 BDEW derating 2 VDE-AR-N derating 3 CEI derating
Reset Country S.	Unlocks the grid standard selection (resets the 24 hours available for changing the grid standard)	
Accept boards	Used to associate a new board with the inverter (in the event of replacement)	



This information is made available through the Aurora Manager Lite software.

- **Date and time:** setting necessary for the correct operation and storage of statistical data of the inverter. It is set to UTC (daylight saving time is NOT considered).

- **RS485 address (1) and (2):** settings required in the case of system monitoring via the RS485 lines;

RS485 (1) default setting on AUTO

RS485 (2) default setting on AUTO

if multiple inverters are connected to the RS485 line, check that they are assigned unique addresses. The addresses that can be assigned go from 2 to 63.

- **Vstart:** Default 420 V

This section of the menu allows you to set the Vstart voltage (for the two channels separately if they are configured independently) to suit the system requirements.



We advise changing the activation voltage only if really necessary and to set it to the correct value: the photovoltaic generator sizing tool available on the ABB website will indicate whether Vstart needs changing and what value to set it at.

- **Alarm**

This section of the menu allows you to set the activation status of a relay (available either as contact normally open – N.O. – or as contact normally closed – N.C.) and to configure customised alarm conditions..

This contact can be used, for example, to: activate a siren or a visual alarm, control the disconnect device of an external transformer, or control an external device.

The relay can be set to switch in different modes:

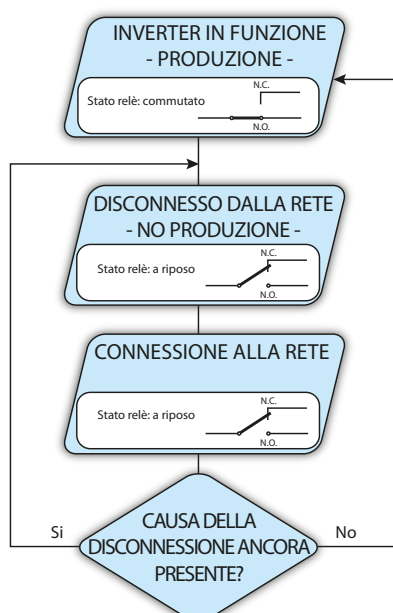

- **Production “PRODUCTION”**

The production mode is the default mode.

The relay is activated (status: switched) whenever the inverter connects to the grid; as soon as the inverter is disconnected from the network (for whatever reason that caused disconnection), the relay is in its resting position.

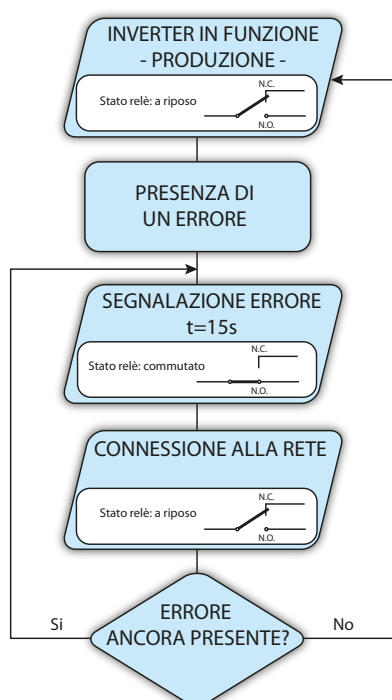

• Alarm with reset at the end of the alarm signalling process "Alarm"

The relay is activated (status: switched) whenever an error (code Exxx) or warnings related to grid parameters out of range (Warning – codes W003, W004, W005, W006, W007) are present on the inverter. The alarm returns to its resting position when the alarm signal ends, i.e. before the inverter checks the grid parameters after the alarm state. This is because grid control state is not an alarm state but a state of normal operation.

Alarms for which the relay is activated

E001	E002	E003	E004	E005	E006
E007	E009	E010	E011	E012	E013
E014	E015	E016	E017	E018	E019
E020	E021	E022	E023	E024	E025
E026	E027	E028	E029	E030	E031
E032	E033	E034	E035	E036	E037
E046	E050	E053	E054	E055	E056
E057	E058	E077	E078	E081	E084
E089	W003	W004	W005	W006	W007



In the presence of W003, W004, W005, W006, W007 signalling, the alarm contact switches to then reset itself at the end of the alarm signal. This means that during the absence of grid voltage (display message "Missing Grid") the alarm contact remains in its resting position.

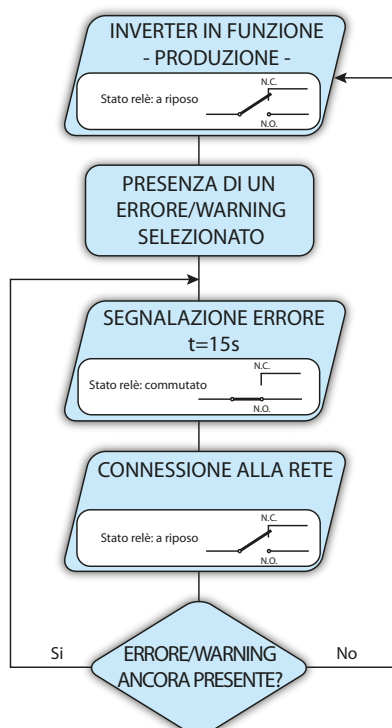

• Configurable alarm with reset at the end of the alarm signalling process "Alarm (Conf.)"

The relay is activated (status: switched) whenever an error (code Exxx) or a warning (code Wxxx) is present from those selected from the list in the dedicated submenu **Alarm Config**. The contact returns to its resting position when the alarm signal ends, i.e. before the inverter checks the grid after the alarm state. This is because grid control state is not an alarm state but a state of normal operation.

Selectable alarms for which the relay is activated

E001	E002	E003	E004	E005	E006
E007	E009	E010	E011	E012	E013
E014	E015	E016	E017	E018	E019
E020	E021	E022	E023	E024	E025
E026	E027	E028	E029	E030	E031
E032	E033	E034	E035	E036	E037
E046	E050	E053	E054	E055	E056
E057	E058	E077	E078	E081	E084
E089	W001	W002	W003	W004	W005
W006	W007	W009	W011	W015	W046
W047	W048	W051	W058	W059	

For the configurable relay operating mode “Alarm Conf.”, the following considerations are valid:

If the alarm condition is persistent, the alarm contact cyclically switches from its resting state to its activated state.

In the presence of W002 signalling (Input UV – input voltage below the limit of operation), the alarm contact switches to then reset itself at the end of the alarm signal. This means that during the reduced input voltage (display message “Waiting Sun”) the alarm contact remains in its resting position.

In the presence of W003, W004, W005, W006, W007 signalling, the alarm contact switches to then reset itself at the end of the alarm signal. This means that during the absence of grid voltage (display message “Missing Grid”) the alarm contact remains in its resting position.

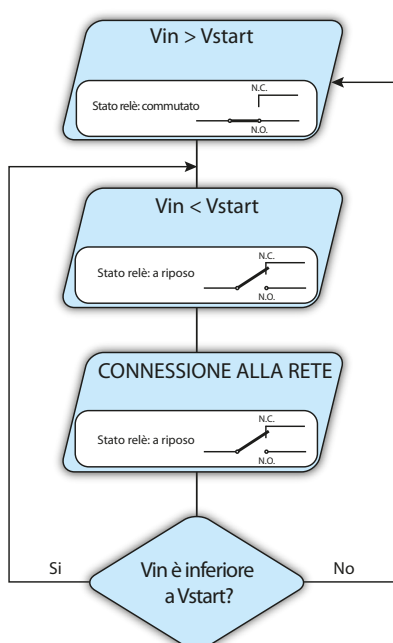

• **Crepuscular “Crepuscular”:**

The relay is activated (status: switched) as soon as the inverter input voltage exceeds the activation voltage set.

The relay is in its rest position when the input voltage drops below 70% of the activation voltage set.

This mode is useful for disconnecting any output transformers that could have unnecessary consumption during the night.

• **Alarm Latch (“Alarm Latch”)**

The relay is activated (status: switched) whenever an error (code Exxx) or a warning (code Wxxx) is present (see the table below). When the inverter returns to the normal operating state and reconnects with the grid, the contact returns to its position of rest.

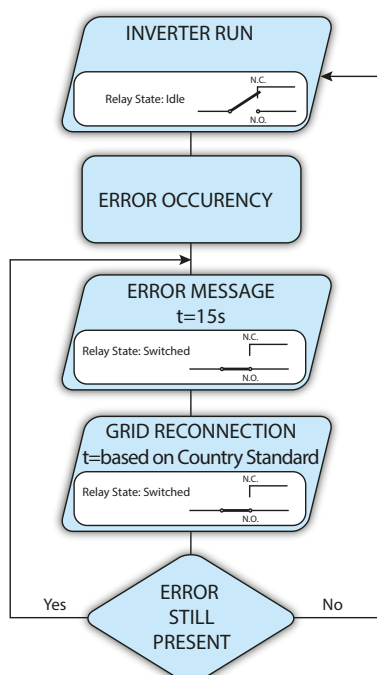

Alarms for which the relay is activated

E001	E002	E003	E004	E005	E006
E007	E009	E010	E011	E012	E013
E014	E015	E016	E017	E018	E019
E020	E021	E022	E023	E024	E025
E026	E027	E028	E029	E030	E031
E032	E033	E034	E035	E036	E037
E046	E050	E053	E054	E055	E056
E057	E058	E077	E078	E081	E084
E089	W003	W004	W005	W006	W007

If the alarm condition is persistent, the relay will remain activated (status:switched)

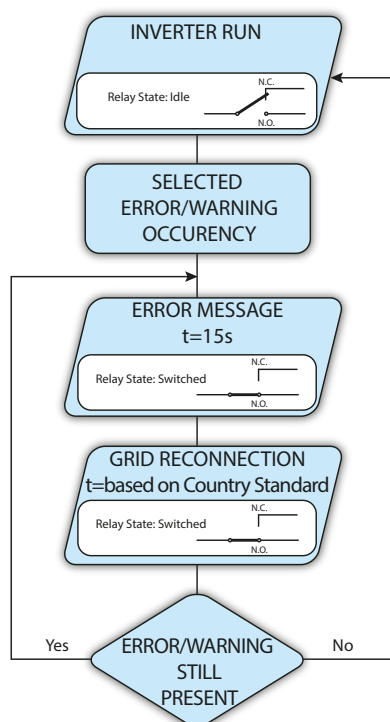

• Latch configurable alarm (display text “Al. Conf. Latch”)

The relay is activated (status: switched) whenever an error (code Exxx) or a warning (code Wxxx) is present from those selected from the list in the dedicated submenu **Alarm Config** (see the table below). When the inverter returns to the normal operating state and reconnects with the grid.

Selectable alarms for which the relay is activated

E001	E002	E003	E004	E005	E006
E007	E009	E010	E011	E012	E013
E014	E015	E016	E017	E018	E019
E020	E021	E022	E023	E024	E025
E026	E027	E028	E029	E030	E031
E032	E033	E034	E035	E036	E037
E046	E050	E053	E054	E055	E056
E057	E058	E077	E078	E081	E084
E089	W001	W002	W003	W004	W005
W006	W007	W009	W011	W015	W046
W047	W048	W051	W058	W059	

If the alarm condition is persistent, the relay will remain activated (status:switched)

• Ext configurable alarm (display text “Al. Conf. Ext.”)

In this mode, it is possible to configure the behaviour of the alarm relay according to an external error table which can be setup with the Aurora Manager LITE software. In the table it is possible to select the alarms or warnings for which the alarm relay is activated (status: switched); for each individual alarm it is also possible to select the “Latch” or “No Latch” mode.

• Remote control: Default OFF

This section allows you to enable/disable the connection/disconnection of the inverter to/from the grid through the relevant control signal (R ON/OFF).

Disable: the connection/disconnection of the inverter to/from the grid is dictated by the input (voltage from the photovoltaic generator) and output (grid voltage) parameters of the inverter.

Enable: the connection/disconnection of the inverter to/from the grid is dictated by the state of the R ON/OFF signal compared to the GND COM signal, as well as by the input (voltage from the photovoltaic generator) and output (grid voltage) parameters of the inverter.

- **Reactive power:** NO default regulation.

This section of the menu may be used to manage the supply of reactive power into the grid. There are 5 possible types of management:

- **No regulation:** no regulation of reactive power. To enable this mode, select **Enable** and then **OK**.

- **Cos-phi fixed:** Sets the power rating to a fixed value. To enable this mode, select **Enable** and then **OK**.

When enabled, **Set value** will appear, allowing you to set the value of Cos-Phi (as either Over or Under excited, from 1.000 to 0.800)

- **Cos-phi = f(P):** Power rating as a function of the active power supplied by the inverter. To enable this mode, select **Enable** and then **OK**.

When it has been enabled, **Load std curve** will appear, allowing you to set the following regulation curve:

The curve can be modified using the Aurora Manager LITE configuration software

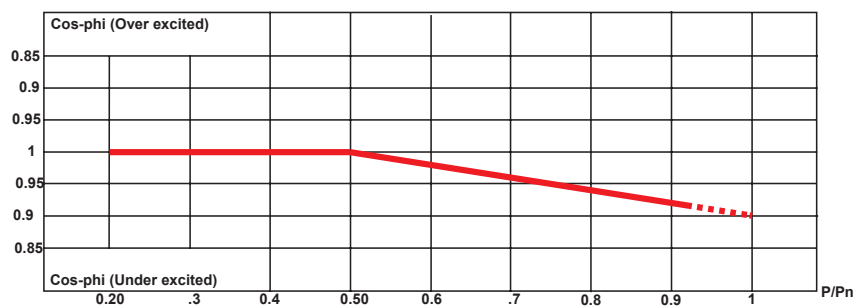

- **Q = f(U):** reactive power as a function of the grid voltage measured by the inverter. To enable this mode, select **Enable** and then **OK**.

When it has been enabled, **Load std curve** will appear, allowing you to set the following regulation curve:

The curve can be modified using the Aurora Manager LITE configuration software

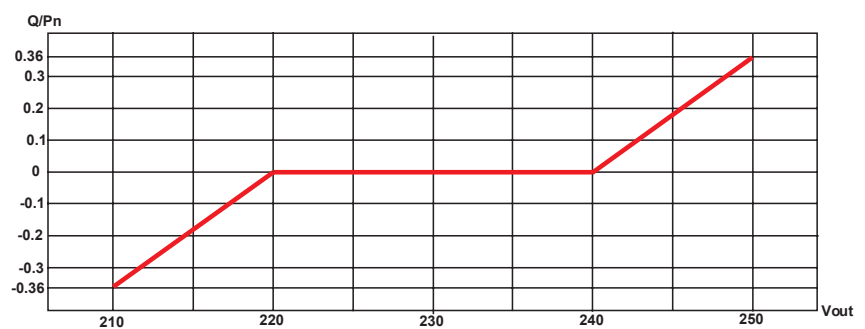

- **UV Protection Time:** Default 60 sec.

This section of the menu allows you to set the time for which the inverter stays connected to the grid after the input voltage has dropped below the Under Voltage limit (set at 70% of V_{start}). ABB sets the time to 60 sec. The user can set it to any time from 1 to 3600 sec.

Example: with UV Prot. Time set at 60 seconds, if voltage V_{in} drops below 70% of V_{start} at 9:00, the inverter stays connected to the grid (taking power from it) until 9:01.

- **MPPT scan:** Default ON (active) allows maximum power point tracking to be carried out.

This section allows you to set the parameters of the maximum power point tracking (MPPT) function. This function is useful when there are areas of shade on the PV generator, which may create several points of maximum power on the operating curve.

- **Multi-max scan:** by setting this parameter, you can enable/disable the scan, decide the frequency with which the scan is carried out and override it manually.

- **Enable/Disable:** Enables/disables the scan for identifying the maximum power point of the system.

- **Scan Interval:** this allows you to set the time between scans. It should be borne in mind that the shorter the scan interval the greater the loss of production, due to the fact that energy is transferred to the grid during the scan but not at the maximum power point. Each scan takes roughly 2 seconds.

- **Power reduction:** Default 100%.

This section allows you to adjust the limit to the active power that the inverter can feed into the grid by setting the percentage of nominal power at which the limit should be triggered.

Setting it to 100% resets the default maximum power, which in some installation country standards may be 110% of nominal power.



The information is available through the dedicated software

This information is made available through the Aurora Manager LITE software.

1. Product ID

This allows the model code and the **T.ID** code to be displayed which identifies the inverter hardware level.

2. Serial No

Allows you to view the equipment serial number.

3. Firmware

Displays the firmware version installed in the equipment and the “update version” field required to request a second-level password for the Service menu (along with the Serial Number and Week of Production).

4. Country standard and language

Displays information on the grid standard set with the rotary switches.

- **Actual value:** Displays the grid standard set.
- **New value:** If the position of the rotary switches is changed (and therefore a new grid standard is selected) during operation, the new standard selected will be displayed. This will only become effective the next time the equipment is turned off and then on again, and provided the time remaining to carry out that operation has not expired (24h in operation)
- **Set new value:** This allows you to confirm/set the new grid standard set in the “New value” section of the previous menu.
- **Residual time:** Displays the time remaining in which it is still possible to set a new grid standard. When the time expires, “Locked” will be displayed, which indicates it is not possible to change the grid standard again.

5. Fuse control (only for -SX / -SY versions)

- **Strings:** Displays the voltage and the state of the strings present at the input of the equipment. A string can be in one of the following states: OK, OFF (damaged) and ABS (Absent)
- **Currents:** Displays the current and the state of the strings present at the input of the equipment. A string current can be in one of the following states: OK, UNB (unbalanced current) and ABS (absent)



Inverter switch-off



Some parts may be very hot and could cause burns.



Some inverter parts may be subject to voltages that could be hazardous for the operator. Before performing any work on the inverter, follow the procedure for turning off the inverter.

AC and DC wiring box version (Standard)

- Open the DC disconnect switch and the AC disconnect switch installed by the Client on the outside of the inverter.
- Disconnect any power supplies that may be connected to the configurable relay.



Before attempting any work on the inverter, wait enough time for the stored energy to be discharged

- Remove the front covers ⑧

Under these conditions the wiring box does not have any hazardous voltages and all areas may be freely accessed.



Dc (-S / -SX / -SY) and AC (-S / -SX) wiring box version

1 Open the DC disconnect switch and the AC disconnect switch installed on the covers of the two wiring boxes

2 Disconnect any power supplies that may be connected to the configurable relay.



3 Before attempting any work on the inverter, wait enough time for the stored energy to be discharged.

4 Remove the front covers ⑧

5 Under these conditions both wiring boxes have hazardous voltages highlighted by the symbol ⚡ while the other areas may be freely accessed.

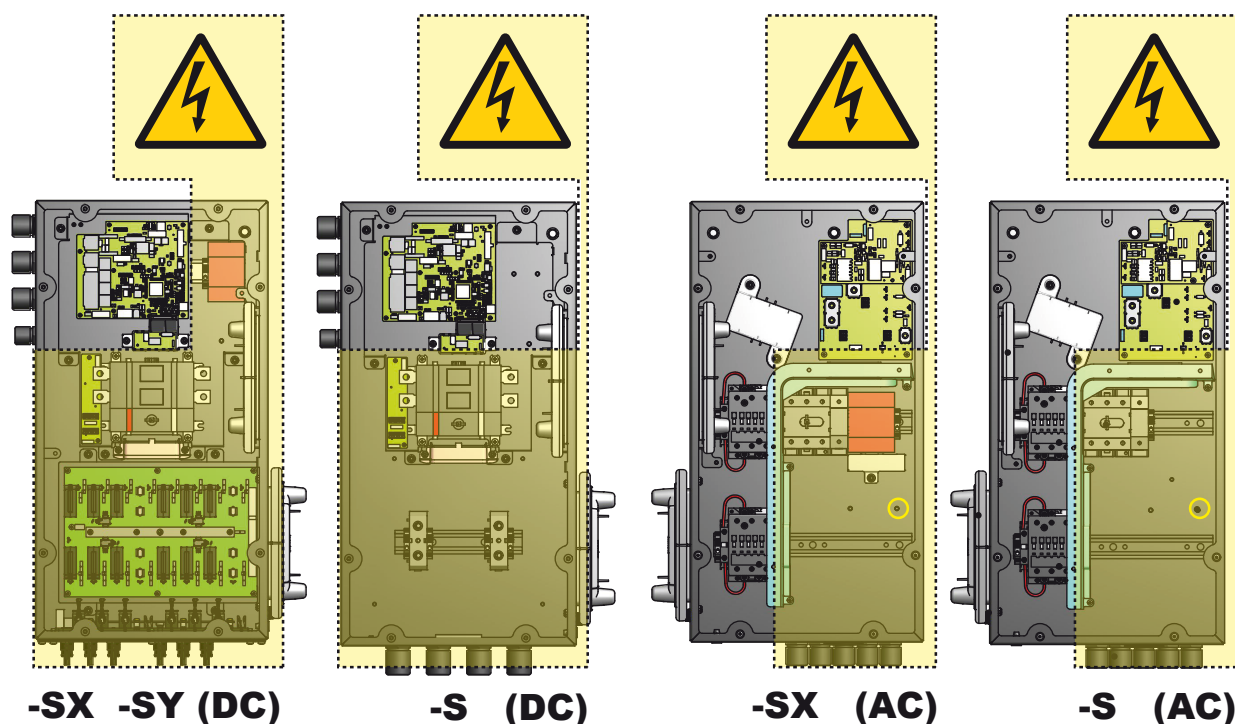

6 Open the DC disconnect switch and the AC disconnect switch installed by the Client on the outside of the inverter.

7 Under these conditions the wiring box does not have any hazardous voltages and all areas may be freely accessed.

Maintenance

8

General conditions

Routine and periodic maintenance operations must only be carried out by specialized staff with knowledge of how to perform these tasks.



Maintenance operations must be performed with the apparatus disconnected from the grid (power switch open) and the photovoltaic panels obscured or isolated, unless otherwise indicated.



*For cleaning, DO NOT use rags made of filamentary material or corrosive products that may corrode the equipment or generate electrostatic charges.
Avoid temporary repairs. All repairs should be carried out using only genuine spare parts.
The maintenance technician is to promptly report any anomalies.*

DO NOT allow the equipment to be used if problems of any kind are found.



Always use personal protective equipment (PPE) provided by the employer and comply with local safety regulations.

Routine maintenance

Routine maintenance operations should not be considered obligatory, but rather as recommended in order to maintain the efficiency of the PV system.



It is recommended that maintenance operations are only performed by qualified personnel or ABB personnel (under a servicing contract). The maintenance schedule may vary depending on the environmental conditions of the installation premises.

Table: routine maintenance

Annual visual inspections

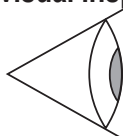

- Check that the inverter is operating properly, without any alarm signals
- Ensure all labels and safety symbols are visible
- Check the integrity of the cables, connectors and cable glands outside the inverter
- Check that the environmental conditions have not changed dramatically from those on installation.
- Check there are no obstacles (animals, insects, leaves or anything which could reduce the heat exchanging capacity of the heat sink) at the top, at the bottom and between the fins.

Annual operations



- Check the tightening of the cable glands and the screw terminal blocks
- Check the front cover is secured to the wiring boxes
- If there is no monitoring system, check the record of alarms and errors using the indications provided in the manual in order to check recent notification of recent malfunctions.
- For the models with AC+DC disconnect switch, it is recommended that once a year the disconnect switch is operated a number of times (at least 10) to keep the contacts clean and prevent oxidation. This operation must be carried out in periods with low input power or at night.

Annual cleaning



- Clean the equipment; verify, in particular, clean the lower array of the cooling fan assembly and the heat sink.

Alarm Messages and troubleshooting

The equipment can notify errors/warnings through the LEDs only if the input voltage is greater than the V_{dcmin} voltage (POWER Led flashing or lit).









The messages and the corresponding codes can only be verified using the designated Aurora Manager LITE software.













Operations on the inverter to identify and address any faults may only be performed by the installer or by qualified personnel.











In order to understand and resolve the warning (Wxxx) or error (Exxx) signals, refer to the table provided in the following paragraph.

Some error/warning codes may not be used depending on the inverter model installed.

- Error code - Error message - Warning	Name of Alarm and Cause	Solution
<ul style="list-style-type: none"> - No code - Ground F -  Red LED 	<p>Ground fault of photovoltaic generator: The alarm is generated when a leakage current to ground is detected in the DC section of the system.</p>	<ul style="list-style-type: none"> • Measure the insulation resistance using a megohmmeter positioned in the photovoltaic array (positive terminal short-circuited at the negative pole) compared to ground. The measurement is strongly influenced by the environmental conditions, so must be made under the same conditions in which the error occurred. - If the value measured is lower than 1 megaohm, a check must be carried out by a technician/installer on the photovoltaic generator to identify and eliminate the problem. - If the value measured is higher than 1 megaohm and the error signal persists, contact customer assistance.
<ul style="list-style-type: none"> - No code - NEW SYSTEM PART REFUSED! -  Flashing yellow LED 	<p>Lack of linkage of the new system part: The components inside the inverter (e.g. display, fuse board, communication and control board, etc.) are not inter-linked. This occurs following the replacement of one of the components inside the inverter.</p>	<ul style="list-style-type: none"> • Link the components inside the inverter by accessing the "Settings > Service > Accept boards" (refer to the procedure given in this manual). - If the signal persists also following the linking of the components, contact customer assistance.
<ul style="list-style-type: none"> - No code - SET COUNTRY or NO NATION -  No LED 	<p>SET COUNTRY or NO NATION: Indicates that in the installation phase the grid standard was not set on the inverter.</p>	<ul style="list-style-type: none"> • Set the grid standard of the country of installation following the instructions given in this manual for the inverter. - If the signal persists also after the grid standard has been set, contact customer assistance.
<ul style="list-style-type: none"> - No code - Missing Grid -  Yellow LED 	<p>Missing Grid: The inverter does not detect grid voltage (AC side).</p>	<ul style="list-style-type: none"> • Check the grid voltage on the inverter's AC terminal block. - Should it be absent, check any protection work on the line and the presence of grid voltage on the supply point.
<ul style="list-style-type: none"> - No code - Memory fault -  Flashing yellow LED 	<p>Memory fault: The inverter has detected a communication problem with the memory board on which the inverter saves the daily value of energy produced.</p>	<ul style="list-style-type: none"> • Remove the memory board and check the welding of all the connector's terminals. Subsequently reinsert the memory board and check that it is correctly inserted into the dedicated slot - If the signal persists also following the above checks, contact customer assistance.
<ul style="list-style-type: none"> - No code - Waiting Sun -  Flashing green LED 	<p>Waiting Sun: The inverter goes into the "Waiting Sun" stage when, following a W001 and/or W002 warning, the voltage from the photovoltaic generator is less than the activation voltage (Vstart).</p>	<ul style="list-style-type: none"> • Check the input voltage on the inverter. - If it does not exceed Vstart, check for the presence of sufficient irradiation and the correct composition of the system. - If it exceeds Vstart, contact customer assistance
<ul style="list-style-type: none"> - W001 - Sun Low -  Yellow LED 	<p>Insufficient irradiation (Low input voltage on switching on the inverter): Incorrect configuration of the PV generator or an "on the limit" configuration for the inverter's minimum input voltage.</p>	<ul style="list-style-type: none"> • Check the input voltage on the inverter. - If it does not exceed Vstart, check for the presence of sufficient irradiation and the correct composition of the system. - If it exceeds Vstart, contact customer assistance
<ul style="list-style-type: none"> - W002 - Input UV -  Yellow LED 	<p>Insufficient irradiation (Low input voltage on switching off): Incorrect configuration of the photovoltaic generator or an "on the limit" configuration for the inverter's minimum input voltage.</p>	<ul style="list-style-type: none"> • Check the input voltage on the inverter. - If it does not exceed Vstart, check for the presence of sufficient irradiation and the correct composition of the system. - If it exceeds Vstart, contact customer assistance
<ul style="list-style-type: none"> - W003 - Grid Fail -  Yellow LED 	<p>Parameters of grid voltage outside range: This error signal occurs when during the inverter's normal operation the grid parameters exceed the limits set by the operator:</p> <ul style="list-style-type: none"> - Grid voltage absent (after the signal the inverter goes to "Missing Grid") - Unstable grid voltage (values too low or too high) - Unstable grid frequency 	<ul style="list-style-type: none"> • Check the grid voltage on the inverter. - Should it be absent, check for absence of grid voltage on the supply point. - If, on the other hand, the voltage tends to rise (when the inverter is connected) there is high line or grid impedance. • Check the grid voltage also on the supply. - If it is high, it means that there is high grid impedance. In this case, ask the operator to adjust the grid voltage. If the operator authorises a change to the inverter's parameters, agree the new limits with customer assistance - If the voltage at the point of supply is much lower than that measured on the inverter, it is necessary to adjust the line (inverter-contactor). - If the voltage and the grid frequency come back within the limits (also when the inverter is connected to the grid), contact customer assistance



- Error code - Error message - Warning	Name of Alarm and Cause	Solution
- W004 - Grid OV -  Yellow LED	Grid overvoltage: This error signal occurs when during the inverter's normal operation the grid voltage exceeds the maximum limit set by the operator.	<ul style="list-style-type: none"> • Check the grid voltage on the inverter. If the voltage tends to rise (when the inverter is connected), there is a problem of high line or grid impedance. • Check the grid voltage also on the supply. <ul style="list-style-type: none"> - If it is high, it means that there is high grid impedance. In this case, ask the operator to adjust the grid voltage. If the operator authorises a change to the inverter's parameters, agree the new limits with customer assistance - If the voltage at the point of supply is much lower than that measured on the inverter, it is necessary to adjust the line (inverter-contactor). - If the voltage and the grid frequency come back within the limits (also when the inverter is connected to the grid), contact customer assistance
- W005 - Grid UV -  Yellow LED	Grid undervoltage: This error signal occurs when during the inverter's normal operation the grid voltage exceeds the minimum limit set by the operator.	<ul style="list-style-type: none"> • Check the grid voltage on the inverter. • Check the grid voltage also on the supply. <ul style="list-style-type: none"> - If it is high, it means that there is high grid impedance. In this case, ask the operator to adjust the grid voltage. If the operator authorises a change to the inverter's parameters, agree the new limits with customer assistance - If the voltage at the point of supply is much lower than that measured on the inverter, it is necessary to adjust the line (inverter-contactor). - If the voltage and the grid frequency come back within the limits (also when the inverter is connected to the grid), contact customer assistance
- W006 - Grid OF -  Yellow LED	Grid over-frequency: This error signal occurs when during the inverter's normal operation the grid frequency exceeds the maximum limit set by the operator.	<ul style="list-style-type: none"> • Check the grid frequency in the inverter. • Check the grid frequency also on the supply: <ul style="list-style-type: none"> - If the voltage and the grid frequency come back within the limits (also when the inverter is connected to the grid), contact customer assistance
- W007 - Grid UF -  Yellow LED	Grid under-frequency: This error signal occurs when during the inverter's normal operation the grid frequency exceeds the minimum limit set by the operator.	<ul style="list-style-type: none"> • Check the grid frequency in the inverter. • Check the grid frequency also on the supply: <ul style="list-style-type: none"> - If the voltage and the grid frequency come back within the limits (also when the inverter is connected to the grid), contact customer assistance
- W009 - Empty Table -  Yellow LED	Characterisation board for the wind generator not compiled (only WIND models)	(only WIND models)
 - W010 * - Fan Fail -  Flashing yellow LED *not visualised on display	Fan Fail: This error occurs when there is a malfunction in the fan/fans inside the inverter.	<ul style="list-style-type: none"> • Error inside the inverter and cannot be checked externally. - If the alarm repeats persistently, contact customer assistance.
- W011 - Bulk UV -  Yellow LED	Low "Bulk" voltage (DC-DC circuit): The alarm (which is a warning and not an error) is generated when the voltage at the heads of the bulk capacitors does not reach the threshold for the operation of the inverter (internal unchangeable threshold).	<ul style="list-style-type: none"> • Raise the value of the activation voltage (Vstart) so as to have sufficient power from the PV generator at the time of the inverter's grid connection. • Check the input voltage on the inverter. <ul style="list-style-type: none"> - If it does not exceed Vstart, check for the presence of sufficient irradiation and the correct composition of the system. - If it exceeds Vstart, contact customer assistance.
- W012 * - Batt. Low -  Flashing yellow LED *not visualised on display	Battery Low: The inverter has detected a backup battery voltage that is too low.	<ul style="list-style-type: none"> • Check that the date/time are set correctly and, if they are not, set them. Subsequently arrange to completely switch off the inverter (on both AC and DC) and wait a few minutes. Finally, restart the inverter and check whether the date/time are now correctly set or whether they have reset to 01/01/2000. In this case replace the battery with the inverter completely switched off (isolate AC and DC side) being careful to maintain the polarity
- W013 * - Clock Fail -  Flashing yellow LED *not visualised on display	Clock Fail: The alarm occurs when there is a difference of more than 1 minute in the time shown on the display or via the advanced configuration software compared to the internal time of the microprocessors and indicates a malfunction of the clock circuit.	<ul style="list-style-type: none"> • Error inside the inverter and cannot be checked externally. - If the alarm repeats persistently, contact customer assistance.

- Error code - Error message - Warning	Name of Alarm and Cause	Solution
- W015 - Island Detect. -  Yellow LED	Disconnection due to Anti-Islanding: The inverter has been improperly connected to an island grid.	<ul style="list-style-type: none"> • Check that the grid to which the inverter is connected is not an island grid. - If the grid to which the inverter is connected is an island grid, switch the inverter off and then on again: if the problem persists, contact customer assistance.
- W017* - String Err. -  Flashing yellow LED * (only for models with monitored string fuses)	Error recorded in measuring string currents: Damaged string protection fuse(s)	<ul style="list-style-type: none"> • Check with a multimeter the state of the fuses (positioned on the fuse boards). - If one or more fuses is open, arrange to replace them and check that the input current on the string(s) does not exceed the rating of the fuses (should parallel strings have been made outside the inverter). - If there are no damaged string fuses and the inverter continues to show the alarm message check whether the settings to be made via the Aurora Manager software are correct (presence or absence of one or more input strings).
- W018 * - SPD DC Err -  Flashing yellow LED * (only for models with monitored SPD)	Intervention of overvoltage surge arresters on DC side: Overvoltage surge arresters situated on the DC side are damaged.	<ul style="list-style-type: none"> • Observe the inspection window on each surge arrester (DC side). If it is red, the surge arrester is damaged and the cartridge must be replaced. - If the alarm status persists, even if all the surge arresters have a green inspection window, contact customer assistance.
- W019 * - SPD AC Err -  Flashing yellow LED * (only for models with monitored SPD)	Intervention of overvoltage surge arresters on AC side: Overvoltage surge arresters situated on the AC side are damaged.	<ul style="list-style-type: none"> • Observe the inspection window on each surge arrester (AC side). If it is red, the surge arrester is damaged and the cartridge must be replaced. - If the alarm status persists, even if all the surge arresters have a green inspection window, contact customer assistance.
W021 - P-reductionStart -  No LED *not visualised on display	Activation of reduction in power: Indicates that one of the power limitations described in the paragraph "Power limitation messages" has been triggered.	<ul style="list-style-type: none"> • Check which power limitation code is active and, on the basis of that, carry out the necessary checks that might relate to various factors including: <ul style="list-style-type: none"> - settings by the user - high grid frequency - high grid voltage - anti-islanding - low grid voltage - high internal temperature - high input voltage
- W022 * - Reactive power mode changed -  No LED *not visualised on display	Variation in means of managing reactive power: Variation in the means of managing reactive power; this change can be made through the display or advanced configuration software.	The variation in the means of managing reactive power is done directly by the customer/installer and is not an error. The information is only saved on the historic record of the events memorised by the inverter
- W023 * - date/time changed -  No LED *not visualised on display	Variation in the inverter's date and time: Variation of the inverter's date and time; this change can be made through the display or advanced configuration software.	<ul style="list-style-type: none"> • The variation in the inverter's date and time is done directly by the customer/installer and is not an error. The information is only saved on the historic record of the events memorised by the inverter
- W024 * - Energy data reset -  No LED *not visualised on display	Zeroing of the statistical energy data memorised in the EEPROM: Reset of the energy data saved in the inverter; this operation can be handled through the display or advanced configuration software.	The zeroing of the partial energy values memorised by the inverter is done directly by the customer/installer and is not an error. The information is only saved on the historic record of the events memorised by the inverter <ul style="list-style-type: none"> • The warning may also occur when the Memory Card on which the production statistics are saved is replaced
W025 - P-reductionEnd -  No LED *not visualised on display	Deactivation of reduction in power: Indicates that the inverter has come out of one of the power limitation states described in the paragraph "Power limitation messages".	This type of warning does not need any check
- W026 * - AFDD user reset -  No LED *not visualised on display	Reset of the Arc Fault error: Manual reset of the Arc Fault error; this operation can be made through the display or advanced configuration software.	<ul style="list-style-type: none"> • The reset of the Arc Fault error is done directly by the customer/installer and is not an error. The information is only saved on the historic record of the events memorised by the inverter



- Error code - Error message - Warning	Name of Alarm and Cause	Solution
- W027 * - Latch-Manual reset - ⊗ No LED *not visualised on display	Resetting of the Latch alarm conditions: Manual reset of the Latch alarm conditions; this operation can be made through the display or advanced configuration software.	<ul style="list-style-type: none"> The reset of the Latch alarm conditions is done directly by the customer/installer and is not an error. The information is only saved on the historic record of the events memorised by the inverter
- W030 - Energy Meter ERROR * - ⊗ No LED * text "METER COM. ERR." shown on the display in the general information (cyclical screens)	METER device communication problem: Error detected on the RS485 serial communication line between the inverter and the energy meter (METER).	<ul style="list-style-type: none"> Check the serial communication line connections between the inverter and the METER. Particularly check the signal correspondence, the correct installation of the conductors and that there are no breaks in the cables. Faulty communication card (Comm. card) Error inside the inverter and cannot be checked externally. If the problem persists (once the inverter has been switched off and back on again), contact customer assistance.
- W031 - BMS fault - ⊗ No LED * text "BMS COM. ERR." shown on the display in the general information (cyclical screens)	Battery unit communication problem: Error detected on the internal communication line between the inverter unit and the battery unit.	<ul style="list-style-type: none"> Check the serial communication line connections between the inverter unit and the battery unit. Particularly check the connectors have been installed correctly and that there are no breaks in the cables connecting the two units. Error inside the inverter and cannot be checked externally. If the problem persists (once the inverter has been switched off and back on again), contact customer assistance.
- W036 - Batt. 1 - W - ⊗ No LED	Problem inside battery unit 1: Problem inside battery unit. This condition can be transitory with automatic reset at the end of the alarm situation	<ul style="list-style-type: none"> Error inside the inverter and cannot be checked externally. If the problem persists (once the inverter has been switched off and back on again), contact customer assistance.
- W037 - Batt. 1 - F1 - ⊗ No LED	Error inside battery unit 1: Problem inside battery unit. This condition can be transitory with automatic reset at the end of the alarm situation	<ul style="list-style-type: none"> Error inside the inverter and cannot be checked externally. If the problem persists (once the inverter has been switched off and back on again), contact customer assistance.
- W039 - Batt. 2 - W - ⊗ No LED	Problem inside battery unit 2: Problem inside battery unit. This condition can be transitory with automatic reset at the end of the alarm situation	<ul style="list-style-type: none"> Error inside the inverter and cannot be checked externally. If the problem persists (once the inverter has been switched off and back on again), contact customer assistance.
- W040 - Batt. 2 - F1 - ⊗ No LED	Error inside battery unit 2: Problem inside battery unit. This condition can be transitory with automatic reset at the end of the alarm situation	<ul style="list-style-type: none"> Error inside the inverter and cannot be checked externally. If the problem persists (once the inverter has been switched off and back on again), contact customer assistance.
- W042 - Batt. 3 - W - ⊗ No LED	Problem inside battery unit 3: Problem inside battery unit. This condition can be transitory with automatic reset at the end of the alarm situation	<ul style="list-style-type: none"> Error inside the inverter and cannot be checked externally. If the problem persists (once the inverter has been switched off and back on again), contact customer assistance.
- W043 - Batt. 3 - F1 - ⊗ No LED	Error inside battery unit 3: Problem inside battery unit. This condition can be transitory with automatic reset at the end of the alarm situation	<ul style="list-style-type: none"> Error inside the inverter and cannot be checked externally. If the problem persists (once the inverter has been switched off and back on again), contact customer assistance.
- W045 - Sys disconnected - ● Yellow LED	Disconnection of system from grid: Warning of disconnection of system from electrical grid (no DC input voltage) because of dead battery pack or no demand from domestic loads	<ul style="list-style-type: none"> Check that, when the warning occurs, the battery pack is dead and/or there have been no energy demands from domestic loads for more than 10 minutes.
- W046 - Grid conn. fault - ● Yellow LED	Connection to the grid unsuccessful The alarm is logged when a Missing grid or Input UV error occurs or due to the manual disconnection of the inverter during the grid connection sequence.	<ul style="list-style-type: none"> Once the error occurs, the inverter tries to return to normal operation. If the problem persists after a number of attempts to connect the inverter, switch the inverter off and then on again. If the problem persists (once the inverter has been switched off and back on again), contact customer assistance.
- W047 - Update Incomplete - ● Yellow LED	FW update method unsuccessful The alarm occurs when a firmware update has not been completed.	<ul style="list-style-type: none"> Complete any pending firmware updates. If the problem persists once the firmware updates have been completed, switch the inverter off and on again. If the problem persists (once the inverter has been switched off and back on again), contact customer assistance.
- W048 - Periodic GridOff - ● Yellow LED	Automatic disconnection from the grid due to time limit: If the inverter exceeds the set grid connection time limit set by the grid standard, it will automatically have to carry out a disconnection and reconnection to the grid to carry out the Riso test.	<ul style="list-style-type: none"> The presence of this alarm is not an error as the automatic disconnection is prescribed by safety regulations. If the inverter disconnects in a shorter time than expected, contact customer assistance.



- Error code - Error message - Warning	Name of Alarm and Cause	Solution
- W049 * - Global-Settings Event - (X) No LED *not visualised on display	Variation of the grid standard Variation of the inverter's grid standard; this change can be made through the display or advanced configuration software.	<ul style="list-style-type: none"> The variation in the inverter's grid standard is done directly by the customer/installer and is not an error. The information is only saved on the historic record of the events memorised by the inverter
- W051 - Exit from Stand Alone connection - (●) Yellow LED	Exit from Stand-alone mode: The alarm is logged when the "Stand Alone" mode is deactivated or the inverter reconnects to the grid (this can only be seen if the Stand Alone accessory board has been installed).	<ul style="list-style-type: none"> Deactivation of the Stand Alone mode is done directly by the customer/installer or automatically by the inverter and is not an error.
- W053 - SOH Low - (X) Flashing yellow LED * text "Bat. Warn-SOH_L" shown on the display in the general information (cyclical screens)	State of health (SOH) of battery pack low: Indicates that the SOH level of the battery pack (during normal operation) is close to the threshold below which it cannot be used. The alarm is displayed for SOH values between 51 and 60%.	<ul style="list-style-type: none"> Indicates that the useful life of the battery is about to end as with SOH values of below 50% it should be replaced.
- W054 - SOH Low (Fault) - (X) Flashing yellow LED * text "Bat. Fault-SOH_L" shown on the display in the general information (cyclical screens)	Battery pack blocked through low state of health (SOH): Indicates that the SOH level of the battery pack (during normal operation) is below the threshold for use. The alarm is displayed for SOH values below 50%.	<ul style="list-style-type: none"> Indicates that the useful life of the battery is over and it must be replaced.
- W055 - Battery Low (0%) - (X) No Led* text "SOC LOW" shown on the display in general information (cyclical screens)	State of charge (SOC) of battery pack low: Indicates that the battery is completely dead.	<ul style="list-style-type: none"> Where permitted by the regulations of the country where it is installed, it is advisable to force the battery to recharge using the electrical grid (charge in AC). Otherwise it is necessary to have good energy production and low absorption of domestic loads to carry out the recharging of the battery (charge in DC).
- W056 - Power Engage - (●) Yellow LED * "CHECK BATT CABLE" is displayed in the general information (cyclical screens)	Problem with battery pack (power) connection cables: Error detected on the power cables between the inverter unit and the battery unit.	<ul style="list-style-type: none"> Check the power line connections between the inverter unit and the battery unit. Particularly check the connectors have been installed correctly and that there are no breaks in the cables connecting the two units. Error inside the inverter and cannot be checked externally. If the problem persists (once the inverter has been switched off and back on again), contact customer assistance.
- W058 - System Frozen - (●) Yellow LED	Converter in locked state: The converter lock state is connected to an installation phase in which the starts-up and grid connection conditions are not yet present.	<ul style="list-style-type: none"> Complete the commissioning phase of the inverter. If the problem persists (once the commissioning phase has been completed and the inverter has been switched off and back on again), contact customer assistance.
- W059 - Output power Overload - (●) Yellow LED	Overload on Stand-alone output: The alarm occurs when there is an excessive request for power by the grid with the inverter in "Stand Alone" mode (this can only be seen if the Stand Alone accessory board has been installed).	<ul style="list-style-type: none"> Disconnect one or more loads from the Stand Alone output. If the problem persists (once all loads have been disconnected and the inverter has been switched off and back on again), contact customer assistance.
- W060 - COMMISSIONING - SOH test - Warning - (X) No LED * text "Bat. Warn-SOH_L" shown on the display in the general information (cyclical screens)	State of health (SOH) of battery pack low: Indicates that the SOH level of the battery pack (during system commissioning) is close to the threshold below which it cannot be used. The alarm is displayed for SOH values between 51 and 60%.	<ul style="list-style-type: none"> Indicates that the useful life of the battery is about to end as with SOH values of below 50% it should be replaced.



- Error code - Error message - Warning	Name of Alarm and Cause	Solution
- W061 - COMMISSIONING - SOH test - Fault - ⊗ No LED * text "Bat. Fault-SOH_L" shown on the display in the general information (cyclical screens)	Battery pack blocked through low state of health (SOH): Indicates that the SOH level of the battery pack (during system commissioning) is below the threshold for use. The alarm is displayed for SOH values below 50%.	<ul style="list-style-type: none"> Indicates that the useful life of the battery is over and it must be replaced.
- W062 - BMS Shutdown err - ⊗ No LED	Disconnection of the battery did not occur: Impossible to disconnect the battery pack (via the system's internal devices) following a command (automatic or manual).	<ul style="list-style-type: none"> Error inside the inverter and cannot be checked externally. If the problem persists (once the inverter has been switched off and back on again), contact customer assistance.
- W063 - Force Grid Disconnection for SA Request - ● Yellow LED	Forced disconnection from grid: The inverter disconnects from the grid following a command input in stand-alone mode	<ul style="list-style-type: none"> This warning is not of an error but is a message informing that the inverter has been forced to disconnect from the grid to go into stand-alone mode
W064 - Battery Firmware Update Failed - ⊗ Flashing yellow LED * "BMS FW UPDT ERR." shown on the display in general information (cyclical screens)	Update of battery unit firmware failed: Indicates that the update of battery unit firmware has failed.	<ul style="list-style-type: none"> Redo the battery unit firmware update procedure. If the error warning is shown again contact customer assistance to check the new firmware's compatibility.
- E001 - Input OC - ● Yellow LED	Input over-current (photovoltaic generator): The alarm occurs when the inverter's input current exceeds the inverter's threshold for maximum input current.	<ul style="list-style-type: none"> Check whether the composition of the PV generator enables input current which exceeds the maximum threshold allowed by the inverter and that the configuration of the inputs (independent or in parallel) is carried out correctly. If both checks are positive, contact customer assistance.
- E002 - Input OV - ● Yellow LED	Input overvoltage (photovoltaic generator): The alarm is generated when the input voltage (from the PV generator) exceeds the inverter's threshold of maximum input voltage. The alarm is triggered before reaching the absolute threshold beyond which the inverter will be damaged. When the inverter's input voltage exceeds the Over Voltage threshold, the inverter will not start up due to the generation of the alarm.	<ul style="list-style-type: none"> It is necessary to measure the input voltage inside the inverter with a voltmeter. If it is higher than the maximum voltage of the operating range, the alarm is genuine and it is necessary to check the configuration of the PV generator. If the voltage has also exceeded the maximum input threshold the inverter could be damaged. If it is lower than the maximum voltage of the operating range, the alarm is caused by an internal malfunction and it is necessary to contact customer assistance.
- E003 - No Parameters - ● Yellow LED	DSP initialisation error: The main microcontroller is unable to correctly initialize the two DSPs (booster stage and inverter stage). The error is caused by communication problems on the inverter's internal bus.	<ul style="list-style-type: none"> Error inside the inverter and cannot be checked externally. If the problem persists (once the inverter has been switched off and back on again), contact customer assistance.
- E004 - Bulk OV - ● Yellow LED	"Bulk" over-voltage (DC-DC circuit): Error inside the inverter. The alarm is raised when the voltage at the heads of the bulk capacitors exceeds the Over Voltage threshold (internal unchangeable threshold).	<ul style="list-style-type: none"> The alarm may be triggered by causes external to the inverter: <ul style="list-style-type: none"> An excessive input voltage can be recorded as a condition for bulk over voltage. In this case it is advisable to check the inverter's input voltage and should this value be close to the input OV threshold, review the configuration of the photovoltaic generator. Excessive grid voltage could cause the bulk voltage to rise in uncontrolled fashion with a consequent protection intervention and hence generation of the alarm. In these cases the alarm is transitory and the inverter automatically restarts The alarm may be triggered by causes inside the inverter and in this case it is necessary to contact customer assistance.
- E005 - Comm.Error - ● Yellow LED	Communication error inside the inverter: The alarm occurs when there are communication problems between the control devices inside the inverter.	<ul style="list-style-type: none"> Error inside the inverter and cannot be checked externally. If the problem persists (once the inverter has been switched off and back on again), contact customer assistance.



- Error code - Error message - Warning	Name of Alarm and Cause	Solution
- E006 - Output OC - Yellow LED	Output overcurrent: The alarm occurs when the inverter's output current exceeds the inverter's threshold for maximum output current.	<ul style="list-style-type: none"> • Error inside the inverter and cannot be checked externally. - If the problem persists (once the inverter has been switched off and back on again), contact customer assistance.
- E007 - IGBT Sat - Yellow LED	Saturation recorded on the IGBT components: The alarm appears when one of the active devices of the inverter is in saturation state.	Once the error appears, the inverter attempts to resume normal operation. <ul style="list-style-type: none"> - Should the error occur sporadically, it may be caused by a brusque transition of the grid voltage or of the input voltage, but is not due to a malfunction by the inverter. - If the error is connected to an internal fault, it will continue to appear and so it is necessary to contact customer assistance.
- E009 - Internal error - Yellow LED	Error inside the inverter: Error inside the inverter	<ul style="list-style-type: none"> • Error inside the inverter and cannot be checked externally. - If the problem persists (once the inverter has been switched off and back on again), contact customer assistance.
- E010 - Bulk Low - Yellow LED	Low "Bulk" voltage (DC-DC circuit): The alarm can be caused by causes external to the inverter: a reduced input voltage on the inverter (just above the activation voltage) but which is not accompanied by a sufficient availability of power from the photovoltaic generator (typical condition of the stages with limited irradiation)	<ul style="list-style-type: none"> - If the error signal occurs sporadically, it may be due to causes external to the inverter (limited irradiation and so limited power availability from the PV generator). - If the problem occurs systematically even in conditions of high irradiation and with input voltage which is significantly higher than the activation voltage, contact customer assistance.
- E011 - Ramp Fail - Yellow LED	Long wait for "Booster" regime to start: Error internal to inverter relating to start up time for DC-DC circuit regime (Booster)	<ul style="list-style-type: none"> • Error inside the inverter and cannot be checked externally. - If the problem persists (once the inverter has been switched off and back on again), contact customer assistance.
- E012 - DcDc Fail - Yellow LED	Error in the "Booster" circuit (DC-DC side) recorded by the "Inverter" circuit (DC-AC side): Error inside the inverter regarding the operation of the DC-DC circuit part (Booster).	<ul style="list-style-type: none"> • Error inside the inverter and cannot be checked externally. - If the problem persists (once the inverter has been switched off and back on again), contact customer assistance.
- E013 - Wrong Mode - Yellow LED	Incorrect configuration of inputs (set in parallel rather than independent): The alarm is generated solely when the inverter is configured with parallel inputs. In this particular configuration the inverter checks the input voltage of each of the two channels and if the two voltages differ by more than 20Vdc, the alarm is raised .	<ul style="list-style-type: none"> • Check that the setting of the "IN MODE" switch is specifically set to "PAR" and that the bridges between the two input channels have been included. - If the configuration of the inverter is correct, check that the input strings have the usual number of standard panels of the usual brand and with the same inclination/orientation. - If both the configuration of the inverter and the characteristics of the PV generator conform with the specifications, contact customer assistance.
- E014 - Over Temp. - Yellow LED	Excessive temperature inside the inverter: External temperature over 60°C. This parameter also depends on the power which the inverter must supply since the measurement of temperatures is done internally and is influenced by the heat dissipated by the components of the inverter itself	<ul style="list-style-type: none"> • Check that the inverter is not exposed to direct sunlight. Wait for the temperatures to which the inverter is exposed to return to the operating range and for the inverter to cool down. - If the problem persists (once the ambient temperature has returned to within the range), contact customer assistance. You must remember to wait for the time necessary to allow the inverter to cool down.
- E015 - Bulk Cap Fail - Yellow LED	Breakdown recorded on the "Bulk" capacitor: Error inside the inverter regarding a problem in the bulk capacitors.	<ul style="list-style-type: none"> • Error inside the inverter and cannot be checked externally. - If the problem persists (once the inverter has been switched off and back on again), contact customer assistance.
- E016 - Inverter Fail - Yellow LED	Error in the "Inverter" circuit (DC-AC side) recorded by the "Booster" circuit (DC-DC side): The alarm is generated when a problem is detected in the inverter circuit part (DC/AC).	<ul style="list-style-type: none"> • Error inside the inverter and cannot be checked externally. - If the problem persists (once the inverter has been switched off and back on again), contact customer assistance.
- E017 - Start Timeout - Yellow LED	Long wait for "Inverter" regime to start up: Error internal to inverter relating to start-up time for the DC-AC circuit regime (Inverter) The alarm can be caused by causes external to the inverter: a reduced input voltage on the inverter (just above the activation voltage) but which is not accompanied by a sufficient availability of power from the photovoltaic generator (typical condition of the stages with limited irradiation)	<ul style="list-style-type: none"> - If the error signal occurs sporadically, it may be due to causes external to the inverter (limited irradiation and so limited power availability from the PV generator). - If the problem occurs systematically even in conditions of high irradiation and with input voltage which is significantly higher than the activation voltage, contact customer assistance.



- Error code - Error message - Warning	Name of Alarm and Cause	Solution
- E018 - Ground Fault - ● Red LED	High leakage current measured on the DC side (photovoltaic generator): The alarm is generated when, during normal operation of the inverter, a leakage current to ground is detected in the DC section of the system. It is also possible that the inverter generates the alarm E018 message also due to AC leakage currents connected to the capacitive nature of the photovoltaic generator compared to ground.	<ul style="list-style-type: none"> • Measure the insulation resistance using a megohmmeter positioned in the photovoltaic array (positive terminal short-circuited at the negative pole) compared to ground. The measurement is strongly influenced by the environmental conditions, so must be made under the same conditions in which the error occurred. - If the value measured is lower than 1 megaohm, a check must be carried out by a technician/installer on the photovoltaic generator to identify and eliminate the problem. - If the value measured is higher than 1 megaohm and the error signal persists, contact customer assistance.
- E019 - leak sense.fail - ● Yellow LED	Failure of test on sensor to measure the leakage current (DC side): Before connecting to the grid the inverter runs a self-test regarding the sensor for the leakage current. The test is carried out by "forcing", in the sensor of the leakage current, a current with a known value: the microprocessor compares the value read with the known value. The error is generated if the comparison between the read value and the known value during the test does not fall within the allowed tolerance.	<ul style="list-style-type: none"> • Error inside the inverter and cannot be checked externally. By its nature, the alarm only occurs prior to connection to the grid - If the problem persists (once the inverter has been switched off and back on again), contact customer assistance.
- E020 - Self Test Error 1 - ● Yellow LED	Failure of the test on the relay of the "Booster" (DC-DC circuit): Before connecting to the grid, the inverter carries out some internal tests. One of these tests concerns the correct operation of the booster relay. The test is carried out by "forcing" the switching of the relay and checking its operation. The error is generated if a problem is found in actioning the relay.	<ul style="list-style-type: none"> • Error inside the inverter and cannot be checked externally. By its nature, the alarm only occurs prior to connection to the grid - If the problem persists (once the inverter has been switched off and back on again), contact customer assistance.
- E021 - Self Test Error 2 - ● Yellow LED	Failure of the test on the inverter's relay (DC-AC circuit): Before connecting to the grid, the inverter carries out some internal tests. One of these tests concerns the correct operation of the inverter relay. The test is carried out by "forcing" the switching of the relay and checking its operation. The error is generated if a problem is found in actioning the relay.	<ul style="list-style-type: none"> • Error inside the inverter and cannot be checked externally. By its nature, the alarm only occurs prior to connection to the grid - If the problem persists (once the inverter has been switched off and back on again), contact customer assistance.
- E022 - Self Test Error 4 - ● Yellow LED	Timeout of the tests undertaken on the relays inside the inverter: Execution time for the self-test carried out on the relay of the DC_AC (inverter) circuit too high. It may indicate a problem connected to the aforementioned relays	<ul style="list-style-type: none"> • Error inside the inverter and cannot be checked externally. - If the problem persists (once the inverter has been switched off and back on again), contact customer assistance.
- E023 - DC in error - ● Yellow LED	Feeding of direct current to grid outside of range: The error is generated if the direct component of the current supplied to the grid exceeds the threshold of 0.5% of the rated operating current. In any case, the inverter does not stop because of the E023 error, but tries to connect to the grid again. The sporadic repetition of the error is a sign of serious grid distortions or sharp irradiation changes, while systematic repetition of the error signal will indicate a breakdown on the inverter	Once the error appears, the inverter attempts to resume normal operation. - Should the error occur sporadically, it may be caused by a brusque transition of the grid voltage or of the input voltage, but is not due to a malfunction by the inverter. - If the error is connected to an internal fault, it will continue to appear and so it is necessary to contact customer assistance.
- E024 - Internal error - ● Yellow LED	Error inside the inverter: Error inside the inverter	<ul style="list-style-type: none"> • Error inside the inverter and cannot be checked externally. - If the problem persists (once the inverter has been switched off and back on again), contact customer assistance.







- Error code - Error message - Warning	Name of Alarm and Cause	Solution
- E025* - Riso Low - ● Yellow LED *not visualised on display	Low value of insulation resistance: Before connecting to the grid the inverter measures the insulation resistance of the PV generator compared to ground. Should the measurement of the insulation resistance be below 1Mohm, the inverter does not connect to the grid and shows the "Riso Low" error. The causes may be: - Damaged PV panel(s). - Junction box(es) of the panels not correctly sealed, so as to permit infiltration by water and/or humidity; - Problems in connections between panels (not perfectly fit); - Poor quality of cable joints; - Presence in the DC section of unsuitable or damaged overvoltage surge arresters outside the inverter (reduced ignition voltage compared to the characteristics of the strings of the PV generator); - Presence of humidity inside any junction box	<ul style="list-style-type: none"> • Measure the insulation resistance using a megohmmeter positioned in the photovoltaic array (positive terminal short-circuited at the negative pole) compared to ground. The measurement is strongly influenced by the environmental conditions, so must be made under the same conditions in which the error occurred. - If the value measured is lower than 1 megaohm, a check must be carried out by a technician/installer on the photovoltaic generator to identify and eliminate the problem. - If the value measured is higher than 1 megaohm and the error signal persists, contact customer assistance.
- E026 - Vref Error - ● Yellow LED	Internal reference voltage outside of range: Wrong measurement of reference voltage inside inverter	<ul style="list-style-type: none"> • Error inside the inverter and cannot be checked externally. - If the problem persists (once the inverter has been switched off and back on again), contact customer assistance.
- E027 - Error Meas V - ● Yellow LED	Grid voltage outside of range: Error in the internal measurement of grid voltage (set by law) to have a redundant measurement (2 measurements on the same parameter made by two different circuits)	<ul style="list-style-type: none"> • Error inside the inverter and cannot be checked externally. - If the problem persists (once the inverter has been switched off and back on again), contact customer assistance.
- E028 - Error Meas F - ● Yellow LED	Grid frequency outside of range: Error in the internal measurement of the grid frequency (imposed by regulations) to have a measurement redundancy (2 measurements on the same parameter carried out by two different circuits).	<ul style="list-style-type: none"> • Error inside the inverter and cannot be checked externally. - If the problem persists (once the inverter has been switched off and back on again), contact customer assistance.
- E029 - Mid Bulk OV - ● Yellow LED	Internal overvoltage on the measurement of the "Mid bulk": Error inside the inverter (only triphase models)	<ul style="list-style-type: none"> • Error inside the inverter and cannot be checked externally. - If the problem persists (once the inverter has been switched off and back on again), contact customer assistance.
- E030 - Error Meas Ileak - ● Yellow LED	High leakage current (DC side): - Error on the internal measurement (performed when the inverter is connected to the grid) of the DC side (PV generator) leakage current with respect to ground (required by regulations) to have a measurement redundancy (2 measurements of the same parameter carried out by two independent circuits)	<ul style="list-style-type: none"> • Error inside the inverter and cannot be checked externally. - If the problem persists (once the inverter has been switched off and back on again), contact customer assistance.
- E031 - Error Read V - ● Yellow LED	Output relay damaged: Measurement of internal voltage on heads of the output relay outside of range. There is too great a difference in voltage between the input and output of the grid connection relay.	<ul style="list-style-type: none"> • Error inside the inverter and cannot be checked externally. - If the problem persists (once the inverter has been switched off and back on again), contact customer assistance.
- E032 - Error Read I - ● Yellow LED	Imbalanced output currents: Measurement of the unbalance in the output voltage (made across the three phases) outside of range (only in three-phase models)	<ul style="list-style-type: none"> • Error inside the inverter and cannot be checked externally. - If the problem persists (once the inverter has been switched off and back on again), contact customer assistance.
- E033 - UTH - ● Yellow LED	Low ambient temperature: Temperature outside the inverter below -25°C	<ul style="list-style-type: none"> • Wait for the temperatures to which the inverter is exposed to return to the operating range. - If the problem persists, contact customer assistance. You must remember to wait for the time necessary to allow the inverter to warm up.
- E034 - Interlock fail - ● Yellow LED	"IGBT" circuitry not ready: Error inside the inverter	<ul style="list-style-type: none"> • Error inside the inverter and cannot be checked externally. - If the problem persists (once the inverter has been switched off and back on again), contact customer assistance.
- E035* - Remote Off - ● Yellow LED *not visualised on display	Inverter awaiting "remote ON" command: The inverter has been switched off remotely (remote OFF) and remains in waiting state for the signal that will switch it on again (remote ON).	<ul style="list-style-type: none"> • Switch the inverter back on remotely. If the unit does not switch on, disable the remote on/off function and switch the equipment off completely and then switch it on again. - If the problem persists (once the Remote ON/OFF function has been reactivated), contact customer assistance.



- Error code - Error message - Warning	Name of Alarm and Cause	Solution
- E036 - Vout Avg error - ● Yellow LED	Average of the measurements of grid voltage outside of range: The average value of the grid voltage (sampled every 10 minutes) does not fall within the permitted ranges. The grid voltage in the point connected to the inverter is too high. This may be caused by a grid impedance that is too high. In the final stage of the timeout, the inverter limits the power to check whether the grid voltage has stabilised into regular parameters. If this does not happen, the inverter disconnects from the grid	<ul style="list-style-type: none"> • Check the grid voltage in the connection point to the inverter. - If the grid voltage differs from the range due to the conditions of the distribution grid, ask the operator to adjust the grid voltage. If the operator authorises a change to the inverter's parameters, agree the new limits with customer assistance.
- E037 - Riso Low - ● Red LED	Low value of the insulation resistance (only with the "Amorphous" mode activated): This error can appear only if the "Amorphous" mode is enabled. This function is enabled only in inverters equipped with grounding kit and is used to monitor the voltage at the ends of the grounding resistor. The error appears when the voltage at the ends of the resistor connected between ground and pole of the photovoltaic generator exceeds 30V for more than 30 minutes or 120V for more than one second.	<ul style="list-style-type: none"> • Check for the presence and correct contact between the two terminals of the grounding resistance installed inside the inverter • Measure the insulation resistance using a megohmmeter positioned in the photovoltaic array (positive terminal short-circuited at the negative pole) compared to ground. The measurement is strongly influenced by the environmental conditions, so must be made under the same conditions in which the error occurred. - If the value measured is lower than 1 megaohm, a check must be carried out by a technician/installer on the photovoltaic generator to identify and eliminate the problem. - If the value measured is higher than 1 megaohm and the error signal persists, contact customer assistance.
E046 - String self test fail - ⊗ No LED	Error during the automatic check of the string voltages (only in models with the "fuse-control" board): In some inverter models it is possible to carry out the check test of the polarity of the strings connected to the input (e.g.:TRIO-20.0/27.6kW). This error signal occurs when, during the test stage, an inverted string is recorded	<ul style="list-style-type: none"> • Section the inverter and check the polarity of the string(s) which the inverter has recorded as inverted. - Once all the strings have been correctly connected, activate the system once again; the inverter will once again check the correct polarity of the string inputs at the end of which it will carry out the checks for the grid connection. - If the problem persists (once the inverter has been switched off and back on again), contact customer assistance.
E049 - AC FF Error - ● Yellow LED	Error in the "AC feed-forward" circuit: Error inside the inverter	<ul style="list-style-type: none"> • Error inside the inverter and cannot be checked externally. - If the problem persists (once the inverter has been switched off and back on again), contact customer assistance.
E050 - AFDD Activated - ● Yellow LED	Arc Fault protection activated: Possible photovoltaic arc detected on the DC side.	<ul style="list-style-type: none"> • If it is the first time this problem has occurred, press the ESC button for 5 seconds and wait for the unit to restart. - If the problem persists (once the inverter has been switched off and back on again), contact customer assistance.
E051 - Safety mem. Fault - ● Yellow LED	Error inside the inverter.	<ul style="list-style-type: none"> • Error inside the inverter and cannot be checked externally. - If the problem persists (once the inverter has been switched off and back on again), contact customer assistance.
E053 - AFDD Fault - ● Yellow LED	Arc Fault board autotest failed: Problem detected during the AFDD board autotest phase.	<ul style="list-style-type: none"> • Error inside the inverter and cannot be checked externally. - If the problem persists (once the inverter has been switched off and back on again), contact customer assistance.
E054 - AFDD comm. Fault - ● Yellow LED	Arc Fault board communication error: Error on the RS485 serial communication detected between the inverter and the AFDD board.	<ul style="list-style-type: none"> • Error inside the inverter and cannot be checked externally. - If the problem persists (once the inverter has been switched off and back on again), contact customer assistance.
E055 - AFDD wrong conf. - ● Yellow LED	Arc Fault board parameter reading error: Error in the parameter reading by the system.	<ul style="list-style-type: none"> • Error inside the inverter and cannot be checked externally. - If the problem persists (once the inverter has been switched off and back on again), contact customer assistance.
E056 - Over Temp. (from external box) - ● Yellow LED	Excessive temperature measured inside the inverter's wiring box: High internal temperature. This error relates to the temperature measured on external boxes (e.g.:TRIO-20.0/27.6kW).	<ul style="list-style-type: none"> • Check that the inverter is not exposed to direct sunlight. Wait for the temperatures to which the inverter is exposed to return to the operating range and for the inverter to cool down. - If the problem persists (once the ambient temperature has returned to within the range), contact customer assistance. Remember to wait the time needed to allow the inverter to cool down
E057 - Vbulk reading error - ● Yellow LED	Input voltage (Vin) higher than booster voltage (Vbulk): The error occurs if the input voltage exceeds the Bulk voltage (voltage on the DC-DC circuit inside the inverter)	<ul style="list-style-type: none"> • It is necessary to measure the input voltage inside the inverter with a voltmeter. - If it is higher than the maximum voltage of the operating range, the alarm is genuine and it is necessary to check the configuration of the PV generator. If the voltage has also exceeded the maximum input threshold the inverter could be damaged. - If it is lower than the maximum voltage of the operating range, the alarm is caused by an internal malfunction and it is necessary to contact customer assistance.

- Error code - Error message - Warning	Name of Alarm and Cause	Solution
E058 - Pin vs Pout check error - Yellow LED	Error in the check of Pin vs Pout: The error occurs if the difference between the measured value of input power and that of output power is greater than the limit imposed internally to the inverter.	<ul style="list-style-type: none"> • Error inside the inverter and cannot be checked externally. - If the problem persists (once the inverter has been switched off and back on again), contact customer assistance.
E065 - Stop Button - Yellow LED	Emergency (stop) button activated: This code marks the activation of the emergency button (button pressed). This warning is activated only where there is DC or AC voltage as, if the emergency button is pressed while it is operating only by battery, it causes the whole system to shut down.	<ul style="list-style-type: none"> • Check that the emergency button has been pressed and if necessary deactivate it. - If the warning persists even though the button has been deactivated, contact customer assistance.
E066 - Charger-Bulk - Yellow LED	Error in the "Charger" circuit: Error internal to inverter relating to the bulk voltage of the circuit linked to battery charger	<ul style="list-style-type: none"> • Error inside the inverter and cannot be checked externally. - If the problem persists (once the inverter has been switched off and back on again), contact customer assistance.
E067 - Charger - OV - Yellow LED	Overvoltage of "battery charger" ("Charger" circuit): Error inside the inverter. The alarm is raised when the battery charger voltage exceeds the overvoltage threshold (internal unchangeable threshold).	<ul style="list-style-type: none"> • The error might continue when the battery is disconnected (e.g. activation of emergency button). • If the message persists and is not linked to the battery being disconnected, contact customer assistance.
E068 - Charger - OC - Yellow LED	Overcurrent of "battery charger" ("Charger" circuit): Error inside the inverter.	<ul style="list-style-type: none"> • Error inside the inverter and cannot be checked externally. - If the problem persists (once the inverter has been switched off and back on again), contact customer assistance.
E069 - Charger-SlowRamp - Yellow LED	Error internal to inverter linked to the battery pack charger circuit ("Charger" circuit):	<ul style="list-style-type: none"> • Error inside the inverter and cannot be checked externally. - If the problem persists (once the inverter has been switched off and back on again), contact customer assistance.
E070 - Charger-preChar. - Yellow LED	Error inside the inverter.	<ul style="list-style-type: none"> • Error inside the inverter probably linked to the fuse in the damaged battery pack; the error cannot be verified externally. - If the problem persists (once the inverter has been switched off and back on again), contact customer assistance.
E074 - Internal error - Yellow LED	Communication error inside the inverter: The alarm occurs when there are communication problems between the control devices inside the inverter.	<ul style="list-style-type: none"> • Error inside the inverter and cannot be checked externally. - If the problem persists (once the inverter has been switched off and back on again), contact customer assistance.
E077 - Internal Error - Yellow LED	Error in the system configuration: Error inside the inverter	<ul style="list-style-type: none"> • Error inside the inverter and cannot be checked externally. - If the problem persists (once the inverter has been switched off and back on again), contact customer assistance.
E078 - Riso Test fail - Yellow LED	Riso test error: Problem detected during the Riso test phase.	<ul style="list-style-type: none"> • Error inside the inverter and cannot be checked externally. - If the problem persists (once the inverter has been switched off and back on again), contact customer assistance.
E079 - Wrong Sequence - Yellow LED	Incorrect Phases connection (Only triphase models) The phases have not been connected correctly to the AC output	<ul style="list-style-type: none"> • Invert two of the phases of the network wiring to the AC terminal block of the inverter.
E081 - Internal Error - Red LED	Inverter fault / Incomplete inverter closing: Fault inside the inverter or incomplete inverter closing (front cover missing or not tightened, cable glands missing or incorrectly tightened, environmental protection IP65 not guaranteed)	<ul style="list-style-type: none"> • If the problem has occurred during the installation phase or during the inverter maintenance phase (therefore the cover has been removed or the cable glands have been acted upon), carry out the following operations: <ul style="list-style-type: none"> - Disconnect the AC grid and DC input from the inverter and check for the front cover and all the cable glands, also checking their correct tightening to ensure environmental protection IP65; reconnect the AC grid and the DC input and attempt to switch the inverter on; if the problem persists, contact customer assistance : - If the front cover and all cable glands are present, disconnect the AC grid and DC input from the inverter and wait 15 minutes at a safe distance, then open the inverter cover and if no smoke/smell of burning is present, check the integrity of the components or the presence of moisture or other abnormal conditions; reconnect the AC grid and DC input and attempt to switch on the inverter; if the problem persists contact customer assistance. • If the problem has occurred after installation or after an inverter maintenance phase (therefore the cover has NOT been removed or the cable glands have NOT been acted upon), disconnect the AC grid and the DC input from the inverter and contact customer assistance.



- Error code - Error message - Warning	Name of Alarm and Cause	Solution
E084 - BackFeed OC -  Yellow LED	Return current to photovoltaic field: The error occurs if the input voltage is particularly low (typically in the evening in conditions of low irradiation) and indicates a return current from the inverter to the photovoltaic panels).	If the error occurs in the evening or in conditions of low irradiation, it must not be considered a problem but a protection intervention for the photovoltaic field. - If the error occurs with good irradiation conditions, switch the inverter off and back on again; if the error persists, contact customer assistance.
E086 - Batt. 1 - F2 -  No LED	Error battery pack 1 unusable: Indicates that the battery pack is unusable and must be replaced.	<ul style="list-style-type: none"> • Error inside battery pack 1 and cannot be checked externally. - If the problem (once the system has been switched off and back on) persists, contact customer assistance.
E087 - Batt. 2 - F2 -  No LED	Error battery pack 2 unusable: Indicates that the battery pack is unusable and must be replaced.	<ul style="list-style-type: none"> • Error inside battery pack 2 and cannot be checked externally. - If the problem (once the system has been switched off and back on) persists, contact customer assistance.
E088 - Batt. 3 - F2 -  No LED	Error battery pack 3 unusable: Indicates that the battery pack is unusable and must be replaced.	<ul style="list-style-type: none"> • Error inside battery pack 3 and cannot be checked externally. - If the problem (once the system has been switched off and back on) persists, contact customer assistance.
E089 - Wrong Wiring -  Yellow LED	Incorrect grid wiring connection on Stand Alone: The error occurs if the grid cables have been incorrectly connected to the Stand Alone output.	<ul style="list-style-type: none"> • Check that the cables on the Stand Alone output have been installed correctly.



Power limitation messages

The equipment can signal possible output power limitations which may occur on the basis of:

- settings made by the user
- settings required by the grid standard of the country of installation
- protective devices inside the inverter

The signals and the messages can only be verified using the Aurora Manager LITE software.

The following table gives the complete list of power limitation messages relating to string inverters.

Some messages may not be used depending on the inverter model installed.

- Message on display - Signal	Name of Derating and Cause	Solution
- LIMxxx% CODE:00	<p>Power limitation: The message indicates that the user has set an output power limitation for the inverter. LIM xxx% = Power reduction percentage Examples: LIM 100% = no power limitation LIM 50% = limitation to 50% of the output nominal power</p>	<ul style="list-style-type: none"> • Check the limitation value in "Settings > Power Reduction".
- LIMxxx% CODE:01	<p>Power limitation for over-frequency: The message indicates that the user has set a power limitation due to over frequency in order to reduce the maximum output power of the inverter when the grid frequency exceeds certain limits. LIM xxx% = Power reduction percentage Examples: LIM 100% = no power limitation LIM 50% = limitation to 50% of the output nominal power</p>	<ul style="list-style-type: none"> • Check the limitation value set in "Settings > Service Power > OF Derating"
- LIMxxx% CODE:02	<p>Power limitation for over-voltage: The message indicates that the user has set a power limitation due to overvoltage (parameter U >(10 min)) in order to reduce the maximum output power of the inverter when the reading of the average grid voltage exceeds certain limits. The sampling of readings is done every 10 minutes (U>(10min)). LIM xxx% = Power reduction percentage Examples: LIM 100% = no power limitation LIM 50% = limitation to 50% of the output nominal power</p>	<ul style="list-style-type: none"> • Check the limitation value in "Settings > Service Power > U>(10min) Der."
- LIMxxx% CODE:03	<p>Anti-islanding power limitation: The message indicates that a power limitation is active since an "islanding" condition has been recorded. LIM xxx% = Power reduction percentage Examples: LIM 100% = no power limitation LIM 50% = limitation to 50% of the output nominal power</p>	<ul style="list-style-type: none"> • If the inverter remains connected to the grid and the limitation is active, contact customer assistance
- LIMxxx% CODE:04	<p>Power limitation due to low grid voltage: The message indicates that an output power limitation may occur since a low grid voltage (AC) condition has been recorded. LIM xxx% = Power reduction percentage Examples: LIM 100% = no power limitation LIM 50% = limitation to 50% of the output nominal power</p>	<ul style="list-style-type: none"> • Check that the grid voltage is lower than the minimal voltage. Should this condition persist, contact the grid operator to resolve the problem.



- Message on display - Signal	Name of Derating and Cause	Solution
- LIMxxx% CODE:05	<p>Power limitation due to excess temperature: The message indicates that a power limitation is active since an excess temperature condition has been recorded inside the inverter (This parameter depends also on the power which the inverter must provide since the measurement of temperatures is taken internally and is influenced by the heat dissipated by the components of the inverter itself). LIM xxx% = Power reduction percentage Examples: LIM 100% = no power limitation LIM 50% = limitation to 50% of the output nominal power</p>	<ul style="list-style-type: none"> • Check that the inverter is not exposed to direct sunlight. Wait for the temperatures to which the inverter is exposed to return to the operating range and for the inverter to cool down. - If the problem (once the ambient temperature has returned within the range) persists, contact customer assistance.
- LIMxxx% CODE:06	<p>Power limitation for input over-voltage: The message indicates that a power limitation is active since an input overvoltage (AC) has been recorded. LIM xxx% = Power reduction percentage Examples: LIM 100% = no power limitation LIM 50% = limitation to 50% of the output nominal power</p>	<ul style="list-style-type: none"> • It is necessary to measure the input voltage inside the inverter with a voltmeter. - If it is higher than the maximum voltage of the operating range, the alarm is genuine and it is necessary to check the configuration of the PV generator. If the voltage has also exceeded the maximum input threshold the inverter could be damaged. - If it is lower than the maximum voltage of the operating range, the alarm is caused by an internal malfunction and it is necessary to contact customer assistance.



Procedure for dismantling the Inverter and wiring box

The inverter consists of an Inverter part and two DC and AC Wiring Boxes which may be dismantled separately.

To dismantling and disassemble the appliance, refer to the chapters:

Mount using a support bracket

- **Vertical wall mounting**
- **Mounting horizontally**

Follow the indications for the mounting procedure but in the reverse order



Perform the steps for “Turning off the inverter” based on the model, before removing one of the two wiring boxes or the inverter itself.

*Never open the wiring boxes in the case of rain, snow or a level of humidity >95%.
Always carefully seal all unused openings.*

Even though the device is equipped with an anti-condensation valve, air with extremely high levels of humidity can lead to the creation of condensation inside the inverter.

As the inverter is almost completely insulated from the outside, condensation can also form after maintenance interventions in certain weather conditions.



During dismantling must be installed caps on interface quick connectors on the inverter parts that are installed and exposed to the elements.



Moreover must also be arranged the temporary ground connections to ensure the grounding of all the parts of the inverter that remain installed on the system.



Obtaining the Aurora Manger LITE credentials - Registering at the “Registration” site

In order to obtain the release credentials for advanced configuration of the inverter using the “Aurora Manager LITE” advanced configuration software, the user must:

- Go online and access <https://registration.abbsolarinverters.com>
- Set the desired language and click on the specific icon to start registration

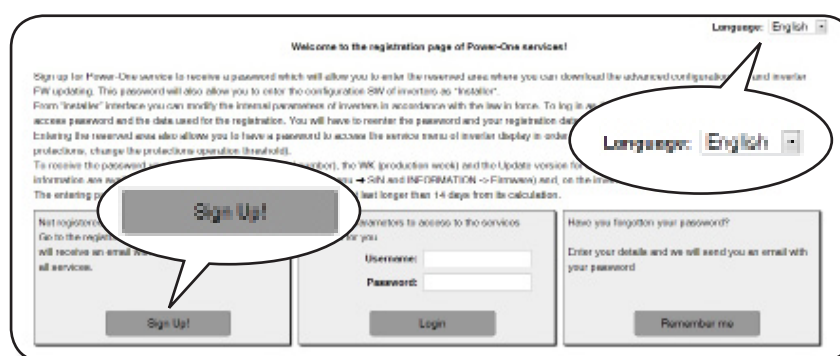

- Insert the personal data requested and end the registration stage
- An email will be sent to the email address used with a link to complete the registration process.
- Once the registration process is over, a further email will be sent with the password to access the website.



The password obtained enables access also to the advanced “Installer” mode present on the configuration software for inverters. The configuration software can be downloaded in a specific section of the website <https://registration.abbsolarinverters.com>

Replacing DC string fuses (-SX / -SY versions)

The string protection fuses in the inverter -SX / -SY versions may need to be replaced in the following circumstances:

1. Adjustment of the fuse value on the basis of the type of PV panels used
2. Damaged fuse

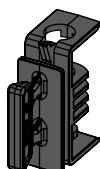

Fuses are replaced using the specific fuse box which allows them to be removed easily and correctly positioned when being inserted.

Procedure for replacing string fuses:

1. Disconnect the strings by disconnecting the DC and AC disconnect switches fitted on the inverter followed by the quick fit input connectors.



By only disconnecting the AC disconnect switch and the DC disconnect switch, the DC input voltage is still present on the fuse board

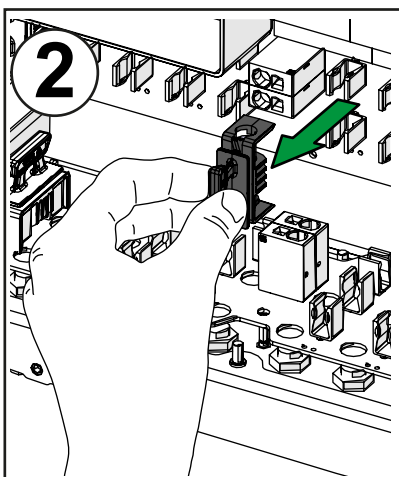

2. Remove the fuse to be replaced acting on the fuse box grip
3. Lift the fuse retaining clip and remove the fuse from the fuse box
4. Introduce the new fuse into the fuse box
5. Fit the fuse box into the wiring box

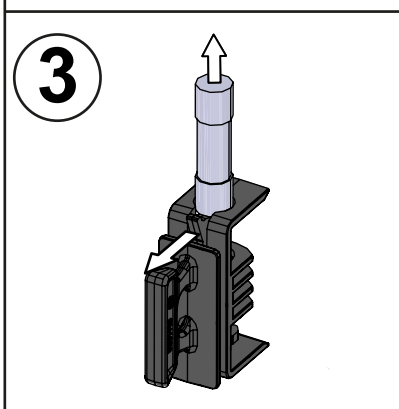

Once the fuse box has been fitted, check that it is in contact with the fuse board.



Replacement of the buffer battery

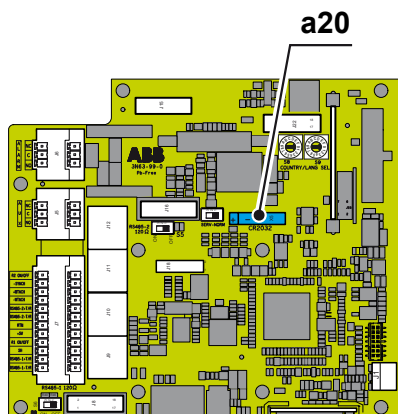

Replacing the buffer battery **a20** is carried out on the DC wiring box ② and may be necessary in the following circumstances:

1. LED error signal
2. Reset of the date and time settings

The battery is of the **CR2032 type** and is installed on the communication and control board ⑨. It can only be accessed after having removed the front cover ⑧ of the DC wiring box installed to protect the areas under high voltage.

Procedure to replace the buffer battery:

1. Disconnect the inverter by disconnecting the DC and AC disconnect switches fitted on the outside of the inverter (Standard version) or the AC and DC disconnect switch (S / -SX / -SY versions) followed by the quick fit input connectors.
2. Open the DC disconnect switch and the AC disconnect switch installed on the covers of the two wiring boxes
3. Remove the front cover ⑧ installed on the DC wiring box ②
4. Remove the buffer battery **a20** to be replaced
5. Install the new battery, taking care to handle it with insulating gloves in order not to compromise the charge and respecting the polarity shown on the diagram on the communication and control board

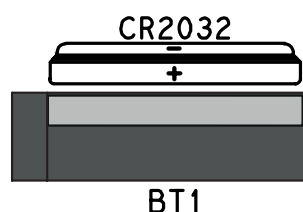
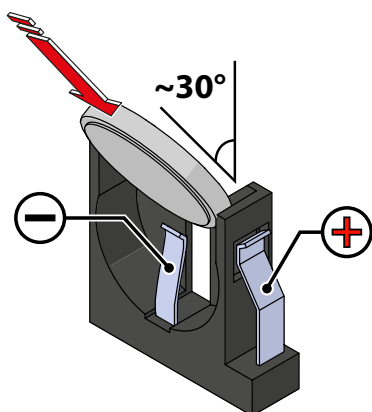

5. Fit the new plastic cover above the communication and control board
6. Reconnect all the input strings and start the inverter.

Verification of ground leakage

In the presence of anomalies or report of ground fault (where provided), there may be a ground leakage from the PV generator (DC side).

To check this, measure the voltage between the positive pole and ground and between the negative pole (of the PV generator) and ground using a voltmeter whose input accepts a voltage sufficient for the dimensions of the photovoltaic generator.

Behaviour of a system without leakage

Due to the capacitive effect of the PV generator, during the first moments that the voltmeter is connected between one of the two poles and ground, it will measure a voltage of about $V_{oc}/2$, which will tend to stabilize to around 0V if there is no ground leakage, as shown in the graph below:

The internal resistance of the voltmeter tends to zero the voltage present on the PV generator due to the capacitive effect.

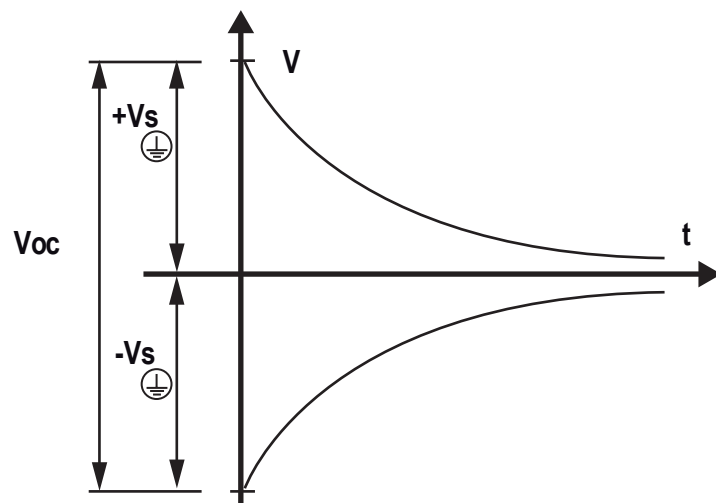

How to make the measurement:

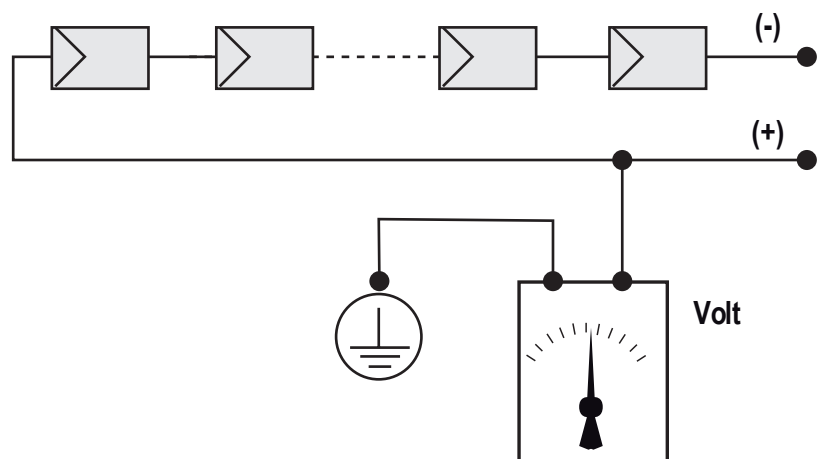

Behaviour of a system with leakage

If the voltage measured between one of the two poles and ground does not tend to 0V and stabilizes on a value, there is a ground leakage from the PV generator.

Example: When the measurement is made between positive pole and ground, a voltage of 200V is measured.

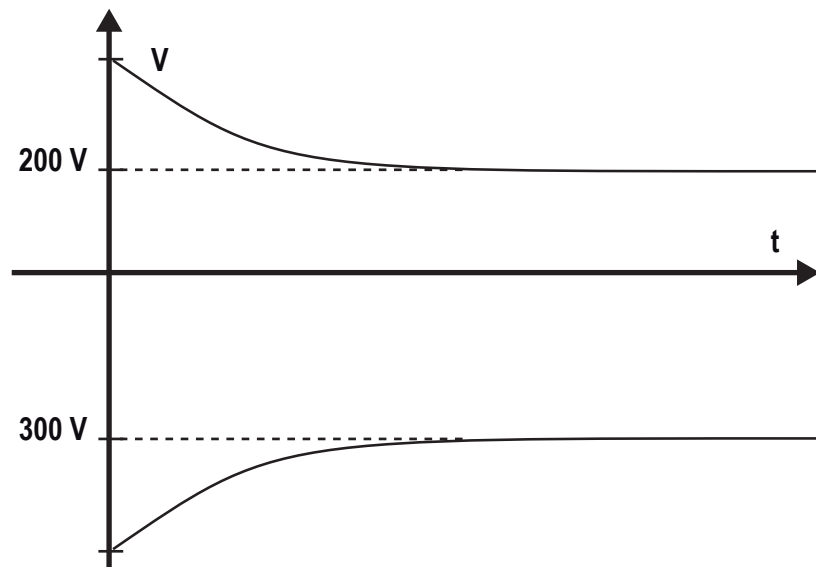

This means that if the system is made up of 10 modules in series and each one supplies 50V, the leakage can be located between the 4th and 5th PV module.

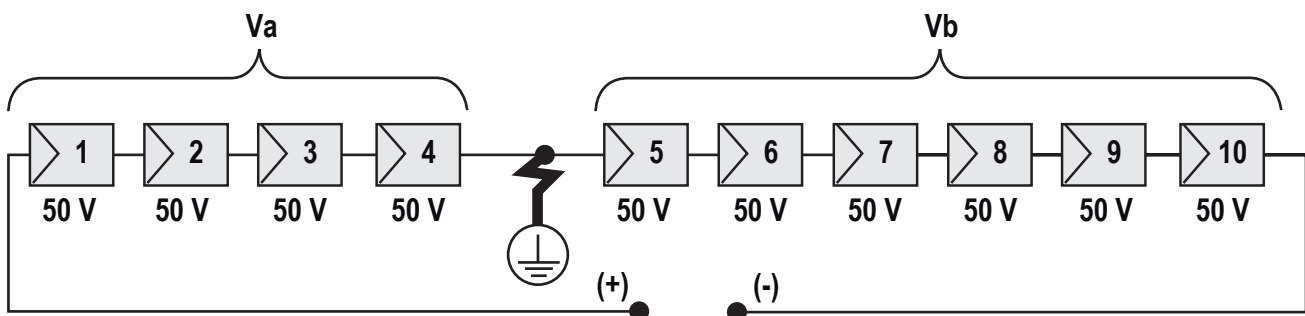

V_a = voltage measured between + pole and \oplus = 200V

V_b = voltage measured between - pole and \oplus = 300V

In all measurements with \oplus , the ground of the inverter is indicated.

Measuring the insulation resistance of the PV generator.

To measure the insulation resistance of the PV generator compared to ground \oplus , the two poles of the PV generator must be short-circuited (using a suitably sized selector).

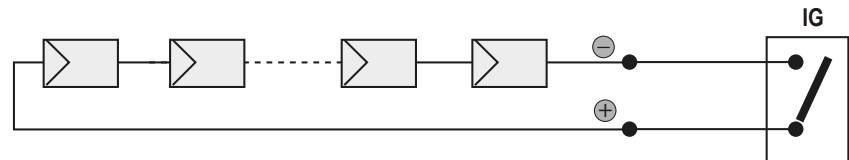

Once the short-circuit has been made, measure the insulation resistance (Riso) using a megohmmeter positioned between the two shorted poles and ground (of the inverter).

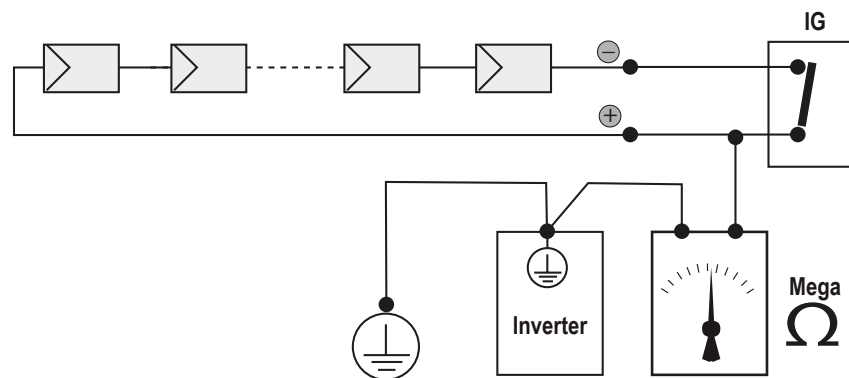

MODELS - TL (without insulation transformer). If the measured insulation resistance (Riso) is less than 500 MOhm, the inverter may not connect to the grid because of low insulation of the PV generator to ground.

MODELS - I (with insulation transformer). If the measured insulation resistance (Riso with floating input poles compared to ground or QF=1 with grounding of one of the two inlet poles) is lower than 0.2 MOhm, the inverter will not connect to the grid due to low insulation of the PV generator to ground.



The insulation resistance can be affected by the environmental conditions the PV generator is in (E.g.: PV modules wet from damp or rain), and therefore the measurement must be made immediately after the anomaly is detected

Storage and dismantling

Storage of the equipment or prolonged stop

If the equipment is not used immediately or is stored for long periods, check that it is correctly packed and contact **ABB** for storage instructions. The equipment must be stored in well-ventilated indoor areas having no characteristics that could damage the components of the equipment.

Restarting after a long or prolonged stop requires a check and, in some cases, the removal of oxidation and dust that will also have settled inside the equipment if not suitably protected.

Dismantling, decommissioning and disposal

ABB is not responsible for any loss of the equipment, or part of it, which does not take place on the basis of the regulations and laws in force in the country of installation.



The symbol of the cancelled bin (where present) indicates that the product must not be disposed of with domestic waste at the end of its useful life.

This product must be delivered to the waste collection point of the local community for recycling.

For further information, refer to the public body responsible for waste disposal in the country.

Inappropriate disposal of waste can have a negative impact on the environment and human health owing to potentially dangerous substances.

By cooperating in the correct disposal of this product, you contribute to the reuse, recycling and recovery of the product, and the protection of our environment.

Dispose of the various types of materials that the parts of the equipment consist of in dumps that are suitable for the purpose.

COMPONENT	MATERIAL OF CONSTRUCTION
Frame, brackets, supports	Arc-welded steel FE37, aluminium
Casing or covers	ABS, plastic
Paint	RAL
Gaskets and seals	Rubber / Teflon / Viton
Electrical cables	Copper / Rubber
Cable trays	Polyethylene / Nylon
Batteries	Nickel / Lead/ Lithium

Further information

For more information on ABB solar products and services,
visit www.abb.com/solarinverters

Contact us

www.abb.com/solarinverters

